

SAMSUNG

EHS

Technical

Data Book

EHS tank integrated Hydro Unit for Europe
(Mono, R32, 50Hz, HP)



Model : Outdoor unit (AE***RXYD*G/EU)
Hydro unit (AE***RNWM*G/EU)

History

Version	Modification	Date	Remark
Ver.1.0	Released EHS tank integrated Hydro Unit for Europe TDB (Mono, R32, 50Hz, HP), 1st Version)	19. 02. 01	
Ver.1.1	Released EHS tank integrated Hydro Unit for Europe TDB (Mono, R32, 50Hz, HP)	19. 05. 07	
Ver.1.2	Modified the Operation range	19. 11. 14	
Ver.2.0	Updated some formats (Specification, Drawing)	21. 08. 27	
Ver.2.1	Modified some contents	21. 11. 12	

Nomenclature

Outdoor Unit

Model Name

AE	050	R	X	Y	D	E	G	/	EU
(1)	(2)	(3)	(4)	(5)	(6)	(7)	(8)		Buyer

(1) Classification

AC	CAC
AM	DVM
AJ	FJM (Free Joint Multi)
AE	EHS

(2) Capacity

X 1/10 kW (3 digits)

(3) Version

R	2019
----------	------

(4) Product Type

S	SET (NASA)
N	Indoor Unit (NASA)
X	Outdoor Unit (NASA)
A	SET (Non NASA)
B	Indoor Unit (Non NASA)
C	Outdoor Unit (Non NASA)

(5) Feature 1

E	Split
T	TDM
Y	MONO

(6) Feature 2

D	Deluxe
P	Premium

(7) Rating Voltage

A	115V, 60hz, 1Φ
B	220V, 60Hz, 1Φ
C	208~230V, 60Hz, 1Φ
D	200~220V, 50Hz, 1Φ
E	220~240V, 50Hz, 1Φ
F	208~230V, 60Hz, 3Φ
G	380~415V, 50Hz, 3Φ

(8) Mode

G	Heat Pump (R32)
----------	-----------------

Nomenclature

Tank integrated hydro unit

Model Name

AE	200	R	N	W	M	E	G	/	EU
(1)	(2)	(3)	(4)	(5)	(6)	(7)	(8)		Buyer

(1) Classification

AC	CAC
AM	DVM
AJ	FJM (Free Joint Multi)
AE	EHS

(2) Capacity

	x Liter (3 digits)
--	--------------------

(3) Version

R	2019
----------	------

(4) Product Type

S	SET (NASA)
N	Indoor Unit (NASA)
X	Outdoor Unit (NASA)
A	SET (Non NASA)
B	Indoor Unit (Non NASA)
C	Outdoor Unit (Non NASA)

(5) Product Notation

W	Tank integrated hydro unit
----------	----------------------------

(6) Feature

S	Split
M	Mono

(7) Rating Voltage

A	115V, 60hz, 1Φ
B	220V, 60Hz, 1Φ
C	208~230V, 60Hz, 1Φ
D	200~220V, 50Hz, 1Φ
E	220~240V, 50Hz, 1Φ
F	208~230V, 60Hz, 3Φ
G	380~415V, 50Hz, 3Φ

(8) Mode

G	Heat Pump (R32)
----------	-----------------

Features & Benefits

Tank integrated hydro unit

Eco-friendly heating – zero ozone impact Eco-friendly Refrigerant R32

Reduce the impact on climate change with a Samsung EHS (Eco Heating System). The R32 refrigerant has an Ozone Depletion Potential (ODP) of zero and a lower Global Warming Potential (GWP) than conventional refrigerants*. It also reduces the amount of refrigerant needed and cuts CO2 emissions**.

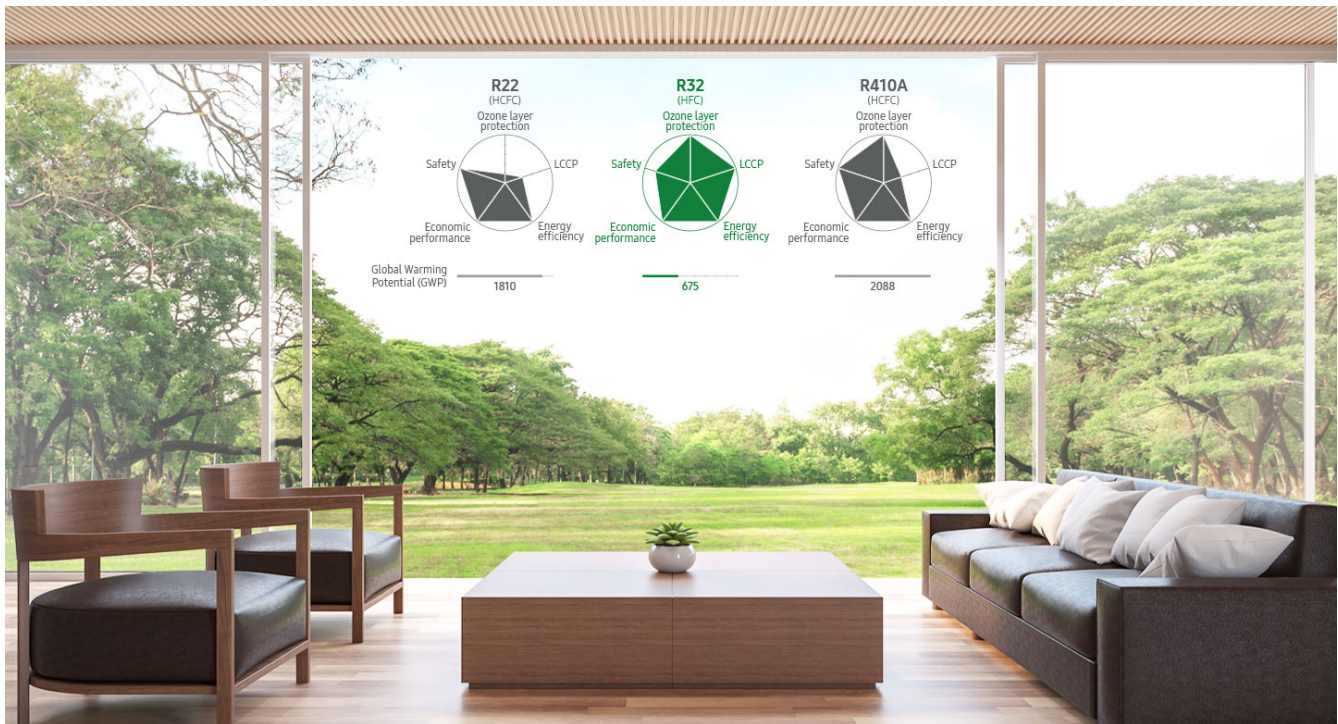

* GWP rating: R32 refrigerant = 675 vs. R410A refrigerant = 2088.

** The Samsung EHS MONO, SPLIT (R32) only requires 83% of the refrigerant used in a conventional heating system (R410A) of the same capacity. So the level of CO2 emissions of the EHS is 560 (675 x 0.83), which is 73% less than the 2088 produced by a conventional heating system.

Mono

The Samsung EHS Mono’s outdoor unit includes the hydraulic parts that provide hot water. It uses water pipes to connect it to an indoor unit. So, it can be easily installed instead of a conventional boiler system.

ClimateHub Mono

Outdoor Unit + Tank Integrated Hydro Unit

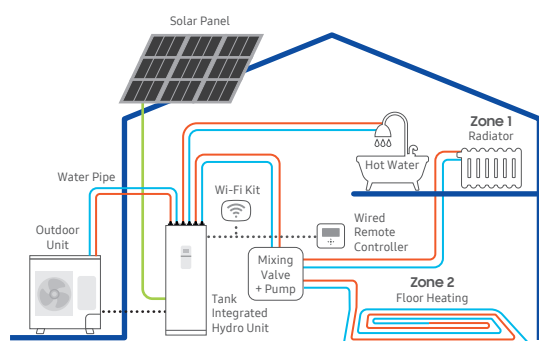

Radiator



Floor heating



Hot water



- Seasonal space heating efficiency: A+++ ~ A++ (on average)
- Leaving water temperature: Up to 65°C
- Capacities: 5, 8, 12, 16kW
- Refrigerant: R32
- Water piping from an outdoor unit
- Power supply: 1Φ 220~240V, 3Φ 380~415V

Features & Benefits

A+++ energy efficiency saves even more

Top Class Energy Efficiency - SCOP A+++

Worry less about the cost of your heating. It has the top class SCOP A+++ energy efficiency rating across the entire range of capacities*. So it is proven to operate with a high level of efficiency, achieving a good heating performance using R32 refrigerant, which has a high PdesignH (kW)**.

* Based on testing defined in EN14825.

** PdesignH is over 100% of the rated capacity, which ensures sufficient heating performance at low temperatures. Based on a standard of -10°C (rating: standard 7°C conditions).

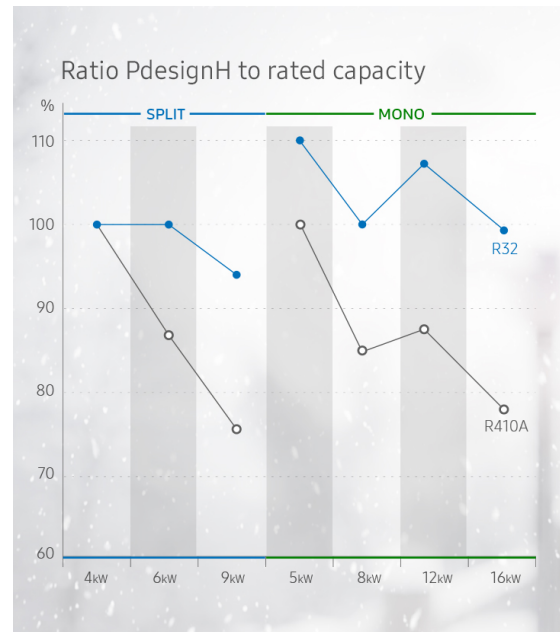

Easy remote control with a smartphone

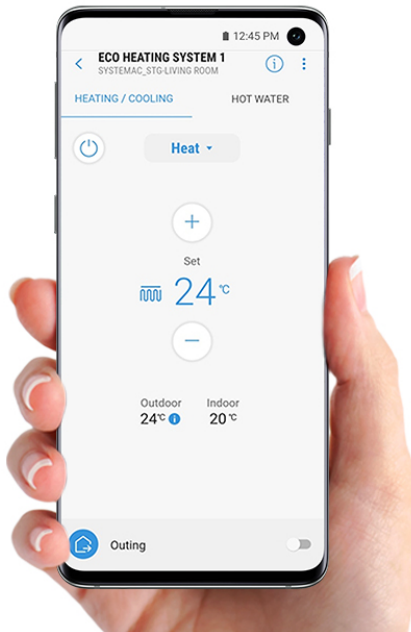

Smart Connectivity

Control your Samsung EHS on the go. Smart Connectivity lets you turn it on/off anytime and anywhere using the SmartThings App*. And, with the touch controller, you can control the mode and settings, schedule it to start/stop, monitor energy use, adjust summer time settings and identify errors.

* Available on Android and iOS devices. A Wi-Fi connection, Samsung account and an optional Wi-Fi Kit (MIM-H04N) are required.

Features & Benefits

Reduce energy usage and save money

Various Functions for Energy Saving

Save energy with advanced functions. The 2-Zone Control optimizes the temperature in two separate zones. The Photovoltaic Enabled feature checks the status of solar panels and reduces network electricity usage. And Smart Grid Ready helps you utilize economical and sustainable power options.



Contents

1. Line-up	9
1-1. Outdoor Units	9
1-2. Tank integrated hydro unit	9
2. Outdoor Units	10
2-1. Specifications	10
2-2. Electrical characteristics	14
2-3. Dimensional drawing	15
2-4. Electrical wiring diagram	18
2-5. Sound data	21
2-6. Operation range	26
2-7. Piping diagram	27
2-8. Capacity table	28
2-9. Silent mode corrections	31
3. Tank integrated hydro unit	32
3-1. Specifications	32
3-2. Dimensional drawing	38
3-3. Electrical wiring diagram	40
3-4. Sound data	42
3-5. Piping diagram	49
4. Installation	50
Tank integrated hydro unit	50
Outdoor Unit	57
Wiring	59

1. Line-up

1-1. Outdoor Units

Capacity		5.0 kW	8.0 kW	12.0 / 16.0 kW
Image				
Model	1 phase	AE050RXYDEG/EU	AE080RXYDEG/EU	AE120RXYDEG/EU AE160RXYDEG/EU
	3 phase	-	AE080RXYDGG/EU	AE120RXYDGG/EU AE160RXYDGG/EU

1-2. Tank integrated hydro unit

Type \ Capacity	200 L	260 L
Model	AE200RNWMEG/EU	AE260RNWM*G/EU
Hydro unit		

2. Outdoor Units

2-1. Specifications

Model Name		Indoor Unit		AE200RNWMEG/EU	AE200RNWMEG/EU	AE200RNWMEG/EU		
		Outdoor Unit		AE050RXYDEG/EU	AE080RXYDEG/EU	AE120RXYDEG/EU		
Power Supply				Φ, #, V, Hz	1,2,220-240,50	1,2,220-240,50	1,2,220-240,50	
Mode				-	Heat Pump (A2W)	Heat Pump (A2W)	Heat Pump (A2W)	
Performance	Capacity	Cooling	A2W Condition #1. (A7/W35) ¹⁾	W	5,000	7,500	12,000	
			Btu/h	17,100	25,600	40,900		
		Heating	A2W Condition #1. (A7/W35) ¹⁾	W	5,000	8,000	12,000	
			Btu/h	17,100	27,300	40,900		
			A2W condition #2	W	4,800	7,400	11,700	
			A2W condition #3		4,300	7,100	11,300	
		A2/W35 ⁴⁾	4,800	7,000	10,800			
		A-7/W35 ⁴⁾	5,100	7,350	12,000			
	Power	Power Input	Cooling	A2W Condition #1. (A7/W35) ¹⁾	W	1,140	1,900	2,770
				Btu/h		3,800	6,100	8,800
			Heating	A2W Condition #1. (A7/W35) ¹⁾		1,030	1,770	2,650
				Btu/h		3,300	5,600	8,700
		A2W condition #2	1,300	2,120	3,180			
		A2W condition #3	1,520	2,530	3,730			
		A2/W35 ⁴⁾	1,450	2,350	3,300			
		A-7/W35 ⁴⁾	1,880	3,020	4,710			
Current Input	Cooling	A2W Condition #1. (A7/W35) ¹⁾	A	5.4	9.1	13.2		
	Heating	4.9		8.5	12.2			
Current	MCA		A	16.0	22.0	28.0		
	MFA		A	20.0	27.5	35.0		
System	Efficiency	EER (Nominal Cooling)			4.39	3.95	4.33	
		COP (Nominal Heating) A2W condition #1			4.85	4.52	4.53	
		COP	A2W condition #2	W/W	3.69	3.49	3.68	
					A2W condition #3	2.83	2.81	3.03
					A2/W35 ⁴⁾	3.31	2.98	3.27
					A-7/W35 ⁴⁾	2.71	2.43	2.55
		PdesignH	LWT 35°C		5.5	8.0	13.0	
			LWT 55°C		5.0	8.0	12.0	
		SCOP	35°C		4.46	4.44	4.69	
			55°C		3.20	3.23	3.51	
	SCOP Class	35°C		A+++	A+++	A+++		
		55°C		A++	A++	A++		
	SEER			3.98	4.52	5.22		
	Water Connections	Water Flow Rate (Nominal) [H/C]		LPM	14.4/14.4	23.1/21.6	34.6/34.6	
		Water Flow Rate	Min	LPM	7.0	7.0	12.0	
			Max	LPM	48.0	48.0	58.0	
Water Pressure (Max)		bar	3	3	3			
Water Pipe Type		threaded male	Inlet	Φ, mm	28	28	28	
			Outlet	Φ, mm	28	28	28	
Leaving Water Temperature		min/max	Heating	°C	15~65	15~65	15~65	
	Cooling		°C	5~25	5~25	5~25		
Refrigerant	Type		-	R32	R32	R32		
	Factory Charging		kg	1.00	1.15	2.20		
			tCO ₂ e	0.68	0.78	1.49		
	Control Method		-	EEV	EEV	EEV		
Outdoor Unit	Compressor	Type		-	BLDC Twin Rotary	BLDC Twin Rotary	BLDC Twin Rotary	
		Model Name		-	UB4TN8200FE45S	UB8TN8265FJWSG	UB5TN5450FJXSG	
		Oil	Type	-	POE	POE	POE	
			Initial Charge	cc	650	700	1,700	
		Quantity		EA	1	1	1	
		Output		W	1623	2078	3613	
Starting method		-	Inverter driven	Inverter driven	Inverter driven			

2. Outdoor Units

2-1. Specifications

Model Name		Indoor Unit		AE200RNWMEG/EU	AE200RNWMEG/EU	AE200RNWMEG/EU	
		Outdoor Unit		AE050RXYDEG/EU	AE080RXYDEG/EU	AE120RXYDEG/EU	
Outdoor Unit	Heat exchanger	Length		mm	730	850	950
		Rows	Quantity	EA	2	2	2
		Fin pitch		mm	1.5	1.5	1.5
		Passes	Quantity	EA	6	8	10
		Face area		m ²	0.55	0.82	1.32
		Stages	Quantity	EA	36	46	66
		Tube type		-	∅7	∅7	∅7.94
	Fin	Type	-	Corrugate	Wide Louver	G-Fin	
		Treatment	-	NGS	Anti Salt	Anti Salt	
	Fan	Type		-	Propeller Fan	Propeller Fan	Propeller Fan
		Discharge direction		-	Horizontal	Horizontal	Horizontal
		Air Flow Rate	Heating	m ³ /min	51	66	99
	Cooling		m ³ /min	51	66	99	
	Fan motor	Quantity		EA	1	1	2
		Model		-	Brushless DC motor	Brushless DC motor	Brushless DC motor
		Output		W X EA	98	125	125 X 2
		Drive		-	Direct drive	Direct drive	Direct drive
		Speed	Heating	rpm	760	780	650
	Cooling		rpm	760	780	650	
	Sound	Sound Pressure	Heating	dB(A)	45	48	50
			Cooling	dB(A)	45	48	50
		Sound Power	Heating	dB(A)	61	63	64
			Cooling	dB(A)	62	64	65
	Connections	Water pipe	inlet	-	BSPP male 1"	BSPP male 1"	BSPP male 1"
			outlet	-	BSPP male 1"	BSPP male 1"	BSPP male 1"
	Casing	Color		-	Earth brown	Earth brown	Earth brown
		Material		-	Poweder coated Galvanised steel	Poweder coated Electro galvanized steel	Poweder coated Electro galvanized steel
Packing	Material		-	EPS/BOX	EPS/BOX	EPS/BOX	
	Weight		kg	4.0	8.5	9.0	
External Dimension	Net Weight		kg	58.5	76.0	110.0	
	Shipping Weight		kg	62.5	84.5	119.0	
	Net Dimensions (WxHxD)		mm	880 x 798 x 310	940 x 998 x 330	940 x 1,420 x 330	
	Shipping Dimensions (WxHxD)		mm	1,023 x 904 x 413	995 x 1,178 x 426	995 x 1,598 x 426	
Operating Temp. Range	Heating		°C	-25~35	-25~35	-25~35	
	Cooling		°C	10~46	10~46	10~46	
	D.Hot Water		°C	-25~43	-25~43	-25~43	

NOTE

- Specifications may be subject to change without prior notice.
- 1)* A2W Condition #1 : (Heating) Water In/Out 30°C/35°C,
Outdoor Air 7°C[DB]/6°C[WB]; (Cooling) Water In/Out 23°C/18°C, Outdoor Air 35°C[DB].
- 2)* A2W Condition #2 : (Heating) Water In/Out 40°C/45°C,
Outdoor Air 7°C[DB]/6°C[WB]; (Cooling) Water In/Out 12°C/7°C, Outdoor Air 35°C[DB].
- 3)* A2W Condition #3 : (Heating) Water In/Out 47°C/55°C, Outdoor Air 7°C[DB]/6°C[WB].
- 4)* A2W Condition : (A2W35) Water In/Out -/35°C,
Outdoor Air 2°C[DB]/1°C[WB]; (A-7/W35) Water In/Out -/35°C, Outdoor Air -7°C[DB]/-(※ Peak Capacity)
- Select wire size based on the value of MCA
- Sound pressure level is obtained in an anechoic room.
 - Sound pressure level is a relative value, depending on the distance and acoustic environment.
 - Sound pressure level may differ depending on operation condition.
 - dB(A) = A-weighted sound pressure level
 - Reference acoustic pressure 0 dB = 20uPa
- Sound power level is an absolute value that a sound source generates.
 - dB(A) = A-weighted Sound power level
 - Reference power : 1pW
 - Measured according to ISO 3741
- These products contain R32 (GWP=675) which is fluorinated greenhouse gas.
- The system is operated in (-25°C ≤ Outdoor temp. < -20°C) condition, but no guarantee of capacity.
- The system is operated by only Booster Heater in special condition (35 °C < Outdoor temp. ≤ 43°C).

2. Outdoor Units

2-1. Specifications

Model Name		Indoor Unit		AE200RNWMGG/EU	AE260RNWMGG/EU	AE260RNWMGG/EU	AE260RNWMGG/EU			
		Outdoor Unit		AE160RXYDEG/EU	AE080RXYDGG/EU	AE120RXYDGG/EU	AE160RXYDGG/EU			
Power Supply				Φ, #, V, Hz	1,2,220-240,50	3,4,380-415,50	3,4,380-415,50	3,4,380-415,50		
Mode				-	Heat Pump (A2W)	Heat Pump (A2W)	Heat Pump (A2W)	Heat Pump (A2W)		
Performance	Capacity	Cooling	A2W Condition #1. (A7/W35) ¹⁾	W	14,000	7,500	12,000	14,000		
			Btu/h	47,800	25,600	40,900	47,800			
		Heating	A2W Condition #1. (A7/W35) ¹⁾	W	16,000	8,000	12,000	16,000		
			Btu/h	54,600	27,300	40,900	54,600			
			A2W condition #2	W	15,400	7,400	11,700	15,400		
			A2W condition #3		15,000	7,100	11,300	15,000		
			A2/W35 ⁴⁾		13,200	7,000	10,800	13,200		
		A-7/W35 ⁴⁾	14,600	7,350	12,000	14,600				
		Power Input	Cooling	A2W Condition #1. (A7/W35) ¹⁾	W	3,280	1,900	2,770	3,280	
	Heating			A2W Condition #1. (A7/W35) ¹⁾		3,620	1,770	2,650	3,620	
	Heating		A2W condition #2	4,490		2,120	3,180	4,490		
			A2W condition #3	5,180		2,530	3,730	5,180		
			A2/W35 ⁴⁾	4,400		2,350	3,300	4,400		
			A-7/W35 ⁴⁾	6,000		3,020	4,710	6,000		
	Current Input		Cooling	A2W Condition #1. (A7/W35) ¹⁾		A	15.7	3.0	4.4	5.3
	Current		MCA	A		32.0	10.0	10.0	12.0	
			MFA	A		40.0	16.1	16.1	16.1	
	System	Efficiency	EER (Nominal Cooling)			4.27	3.95	4.33	4.27	
COP (Nominal Heating) A2W condition #1				4.42	4.52	4.53	4.42			
COP			A2W condition #2	W/W	3.43	3.49	3.68	3.43		
					A2W condition #3	2.90	2.81	3.03	2.90	
			A2/W35 ⁴⁾		3.00	2.98	3.27	3.00		
			A-7/W35 ⁴⁾		2.43	2.43	2.55	2.43		
			PdesignH		LWT 35°C	16.0	8.0	13.0	16.0	
SCOP			LWT 55°C	16.0	8.0	12.0	16.0			
			35°C	4.48	4.44	4.69	4.48			
SCOP Class			55°C	3.53	3.23	3.51	3.53			
			35°C	A+++	A+++	A+++	A+++			
SEER			55°C	A++	A++	A++	A++			
Water Connections		Water Flow Rate (Nominal) [H/C]		LPM	46.2/40.4	23.1/21.6	34.6/34.6	46.2/40.4		
		Water Flow Rate	Min	LPM	12.0	7.0	12.0	12.0		
			Max	LPM	58.0	48.0	58.0	58.0		
		Water Pressure (Max)		bar	3	3	3	3		
		Water Pipe Type	threaded male	Inlet	Φ, mm	28	28	28	28	
				Outlet	Φ, mm	28	28	28	28	
	Leaving Water Temperature	min/max	Heating	°C	15~65	15~65	15~65	15~65		
			Cooling	°C	5~25	5~25	5~25	5~25		
Refrigerant	Type		-	R32	R32	R32	R32			
	Factory Charging	kg	2.20	1.15	2.20	2.20				
		tCO ₂ e	1.49	0.78	1.49	1.49				
	Control Method		-	EEV	EEV	EEV	EEV			
Outdoor Unit	Compressor	Type		-	BLDC Twin Rotary	BLDC Twin Rotary	BLDC Twin Rotary	BLDC Twin Rotary		
		Model Name		-	UB5TN5450FJXSG	UB8TN8265FJWSG	UB5TN5450FJXSG	UB5TN5450FJXSG		
		Oil	Type	-	POE	POE	POE	POE		
			Initial Charge	cc	1,700	700	1,700	1,700		
		Quantity		EA	1	1	1	1		
		Output		W	3613	2078	3613	3613		
Starting method		-	Inverter driven	Inverter driven	Inverter driven	Inverter driven				

2. Outdoor Units

2-1. Specifications

Model Name		Indoor Unit		AE200RNWMGG/EU	AE260RNWMGG/EU	AE260RNWMGG/EU	AE260RNWMGG/EU	
		Outdoor Unit		AE160RXYDEG/EU	AE080RXYDGG/EU	AE120RXYDGG/EU	AE160RXYDGG/EU	
Outdoor Unit	Heat exchanger	Length		mm	950	850	950	950
		Rows	Quantity	EA	2	2	2	2
		Fin pitch		mm	1.5	1.5	1.5	1.5
		Passes	Quantity	EA	10	8	10	10
		Face area		m ²	1.32	0.82	1.32	1.32
		Stages	Quantity	EA	66	46	66	66
		Tube type		-	Ø7.94	Ø7	Ø7.94	Ø7.94
		Fin	Type	-	G-Fin	Wide Louver	G-Fin	G-Fin
	Treatment		-	Anti Salt	Anti Salt	Anti Salt	Anti Salt	
	Fan	Type		-	Propeller Fan	Propeller Fan	Propeller Fan	Propeller Fan
		Discharge direction		-	Horizontal	Horizontal	Horizontal	Horizontal
		Air Flow Rate	Heating	m ³ /min	118	66	99	118
			Cooling	m ³ /min	118	66	99	118
	Fan motor	Quantity		EA	2	1	2	2
		Model		-	Brushless DC motor	Brushless DC motor	Brushless DC motor	Brushless DC motor
		Output		W X EA	125 X 2	125	125 X 2	125 X 2
		Drive		-	Direct drive	Direct drive	Direct drive	Direct drive
		Speed	Heating	rpm	750	780	650	750
			Cooling	rpm	750	780	650	750
	Sound	Sound Pressure	Heating	dB(A)	52	48	50	52
			Cooling	dB(A)	54	48	50	54
		Sound Power	Heating	dB(A)	66	63	64	66
			Cooling	dB(A)	68	64	65	68
	Connections	Water pipe	inlet	-	BSPP male 1"	BSPP male 1"	BSPP male 1"	BSPP male 1"
			outlet	-	BSPP male 1"	BSPP male 1"	BSPP male 1"	BSPP male 1"
	Casing	Color		-	Earth brown	Earth brown	Earth brown	Earth brown
		Material		-	Powder coated Electro galvanized steel	Powder coated Electro galvanized steel	Powder coated Electro galvanized steel	Powder coated Electro galvanized steel
	Packing	Material		-	EPS/BOX	EPS/BOX	EPS/BOX	EPS/BOX
		Weight		kg	9.0	8.5	9.0	9.0
	External Dimension	Net Weight		kg	110.0	75.0	111.0	111.0
Shipping Weight		kg	119.0	83.5	120.0	120.0		
Net Dimensions (WxHxD)		mm	940 x 1,420 x 330	940 x 998 x 330	940 x 1,420 x 330	940 x 1,420 x 330		
Shipping Dimensions (WxHxD)		mm	995 x 1,598 x 426	995 x 1,178 x 426	995 x 1,598 x 426	995 x 1,598 x 426		
Operating Temp. Range	Heating		°C	-25~35	-25~35	-25~35	-25~35	
	Cooling		°C	10~46	10~46	10~46	10~46	
	D.Hot Water		°C	-25~43	-25~43	-25~43	-25~43	

NOTE

- Specifications may be subject to change without prior notice.
 - * A2W Condition #1 : (Heating) Water In/Out 30°C/35°C, Outdoor Air 7°C[DB]/6°C[WB]; (Cooling) Water In/Out 23°C/18°C, Outdoor Air 35°C[DB].
 - * A2W Condition #2 : (Heating) Water In/Out 40°C/45°C, Outdoor Air 7°C[DB]/6°C[WB]; (Cooling) Water In/Out 12°C/7°C, Outdoor Air 35°C[DB].
 - * A2W Condition #3 : (Heating) Water In/Out 47°C/55°C, Outdoor Air 7°C[DB]/6°C[WB].
 - * A2W Condition : (A2W35) Water In/Out -/35°C, Outdoor Air 2°C[DB]/1°C[WB]; (A-7/W35) Water In/Out -/35°C, Outdoor Air -7°C[DB]/-(※ Peak Capacity)
- Select wire size based on the value of MCA
- Sound pressure level is obtained in an anechoic room.
 - Sound pressure level is a relative value, depending on the distance and acoustic environment.
 - Sound pressure level may differ depending on operation condition.
 - dBA = A-weighted sound pressure level
 - Reference acoustic pressure 0 dB = 20uPa
- Sound power level is an absolute value that a sound source generates.
 - dBA = A-weighted Sound power level
 - Reference power : 1pW
 - Measured according to ISO 3741
- These products contain R32 (GWP=675) which is fluorinated greenhouse gas.
- The system is operated in (-25°C ≤ Outdoor temp. < -20°C) condition, but no guarantee of capacity.
- The system is operated by only Booster Heater in special condition (35 °C < Outdoor temp. ≤ 43°C).

2. Outdoor Units

2-2. Electrical characteristics

Capacity [kW]	Model	Power Supply				Voltage Range [V]		Nominal Running Current [A]		Current [A]	
		Φ	#	Hz	Voltage	Min. (-10%)	Max. (+10%)	Cooling	Heating	MCA	MFA
5.0	AE050RXYDEG/EU	1	2	50	220~240	198	264	5.4	4.9	16.0	20.0
8.0	AE080RXYDEG/EU	1	2	50	220~240	198	264	9.1	8.5	22.0	27.5
12.0	AE120RXYDEG/EU	1	2	50	220~240	198	264	13.2	12.2	28.0	35.0
16.0	AE160RXYDEG/EU	1	2	50	220~240	198	264	15.7	17.0	32.0	40.0
8.0	AE080RXYDGG/EU	3	4	50	380~415	342	456	3.0	2.8	10.0	16.1
12.0	AE120RXYDGG/EU	3	4	50	380~415	342	456	4.4	4.1	10.0	16.1
16.0	AE160RXYDGG/EU	3	4	50	380~415	342	456	5.3	5.7	12.0	16.1

NOTE

- MCA : Minimum circuit amperes
- MFA : Maximum fuse amperes
- Select wire size based on the value of MCA

2. Outdoor Units

2-3. Dimensional drawing

AE050RXYDEG/EU

Units : mm [inches]

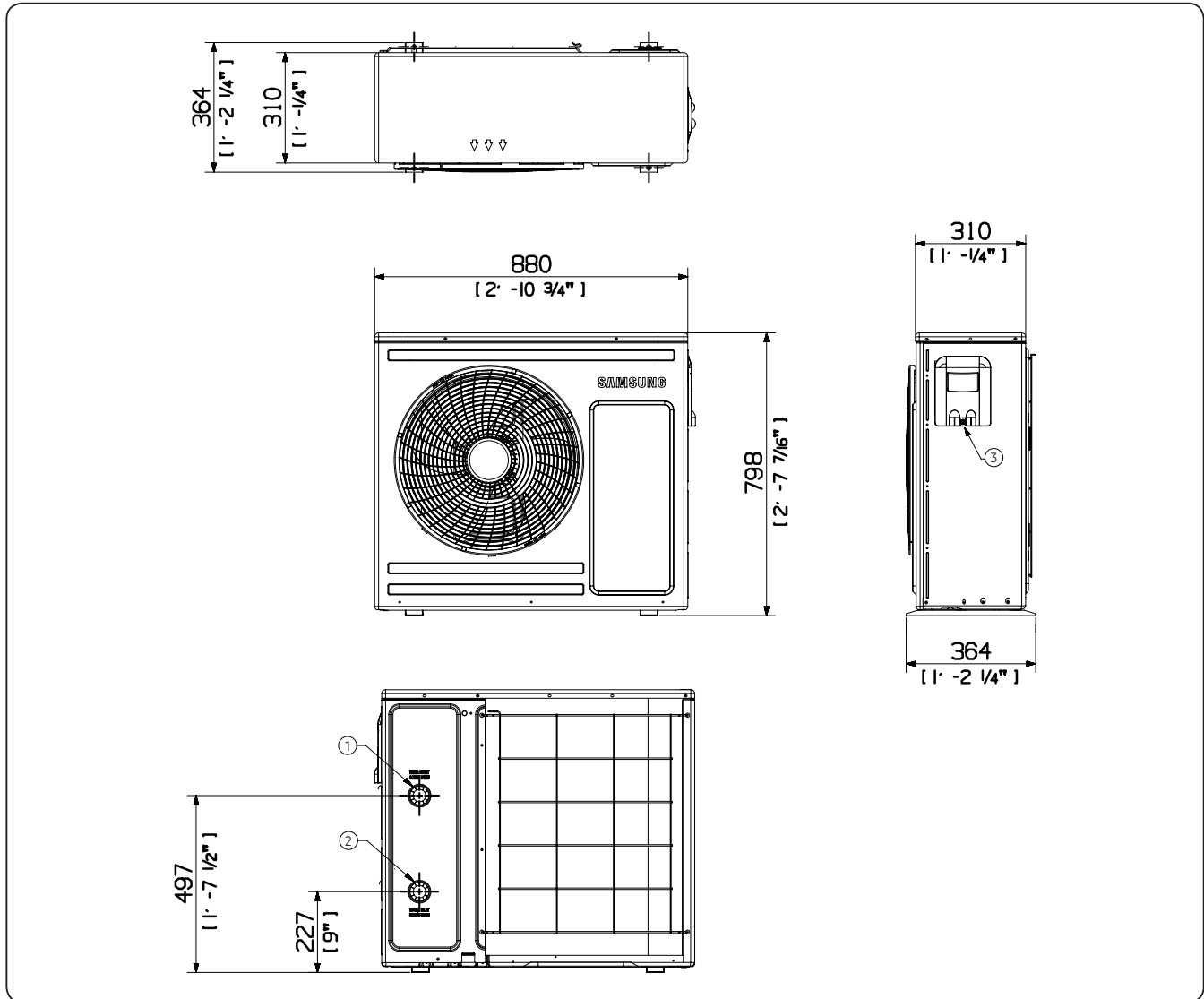

NO	Description
1	Water Pipe(Out)
2	Water Pipe(In)
3	Power & Communication Wiring Conduit Holes

2. Outdoor Units

2-3. Dimensional drawing

AE080RXYD*G/EU

Units : mm [inches]

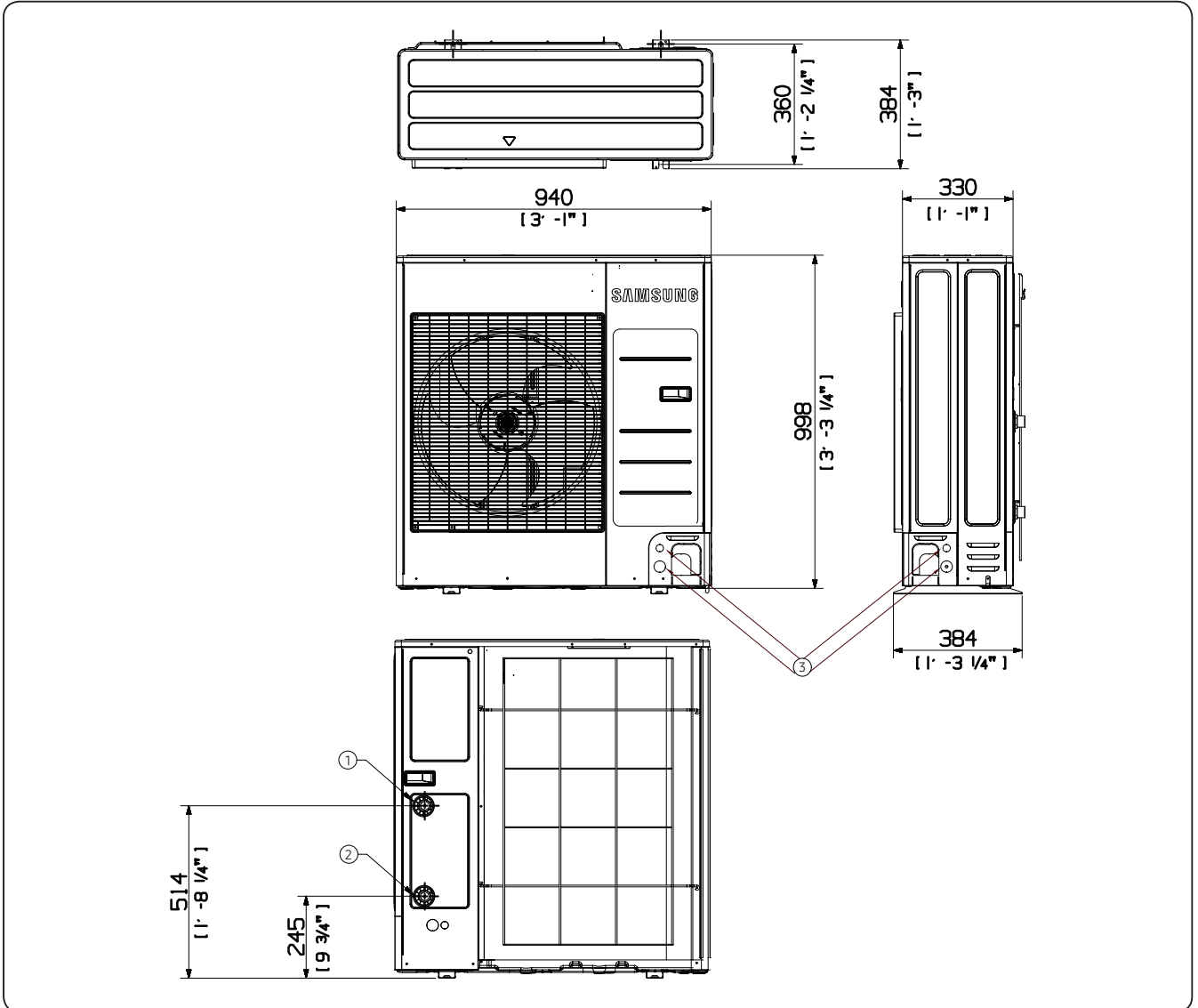

NO	Description
1	Water Pipe(Out)
2	Water Pipe(In)
3	Power & Communication Wiring Conduit Holes

2. Outdoor Units

2-3. Dimensional drawing

AE120/160RXYD*G/EU

Units : mm [inches]

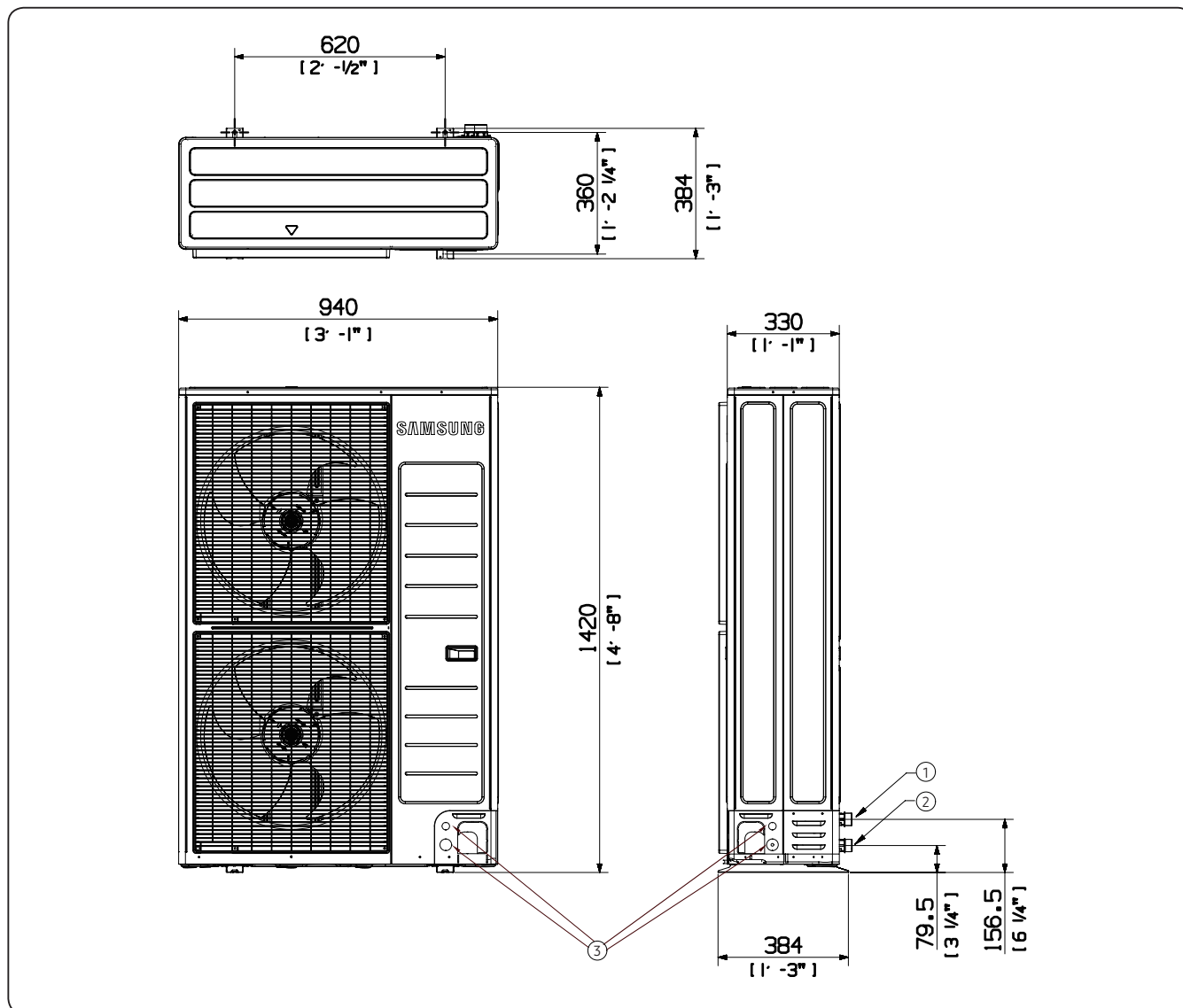

NO	Description
1	Water Pipe(Out)
2	Water Pipe(In)
3	Power & Communication Wiring Conduit Holes

2. Outdoor Units

2-4. Electrical wiring diagram

AE050RXYDEG/EU

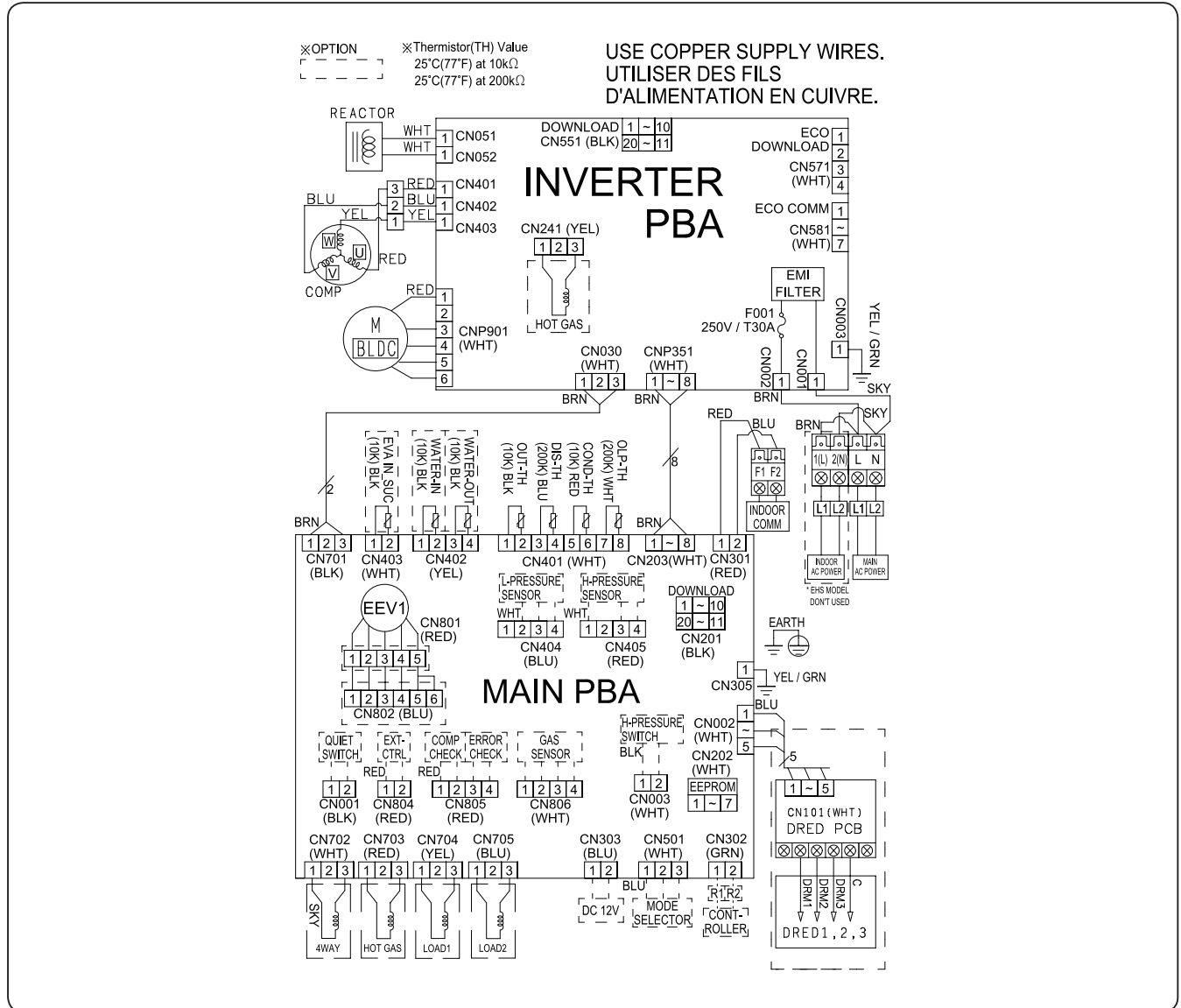

M BLDC	BLDC FAN MOTOR	COMP	COMPRESSOR
OUT-TH	Thermistor OUT(10K)	DIS-TH	Thermistor DISCHARGE(200K)
COND-TH	Thermistor COND(10K)	OLP-TH	Thermistor OLP(200K)

NOTES

1. This wiring diagram applies only to the Outdoor unit.
2. Symbols show as follow :
 blk: black, red: red, blu: blue, wht: white, yel: yellow, brn: brown, sky: skyblue, grn: green
3. For connection wiring indoor-outdoor transmission F1-F2, indoor-wired remote controller transmission F3-F4.
4. Protective earth(SCREW)

2. Outdoor Units

2-4. Electrical wiring diagram

AE080/120/160RXYDEG/EU

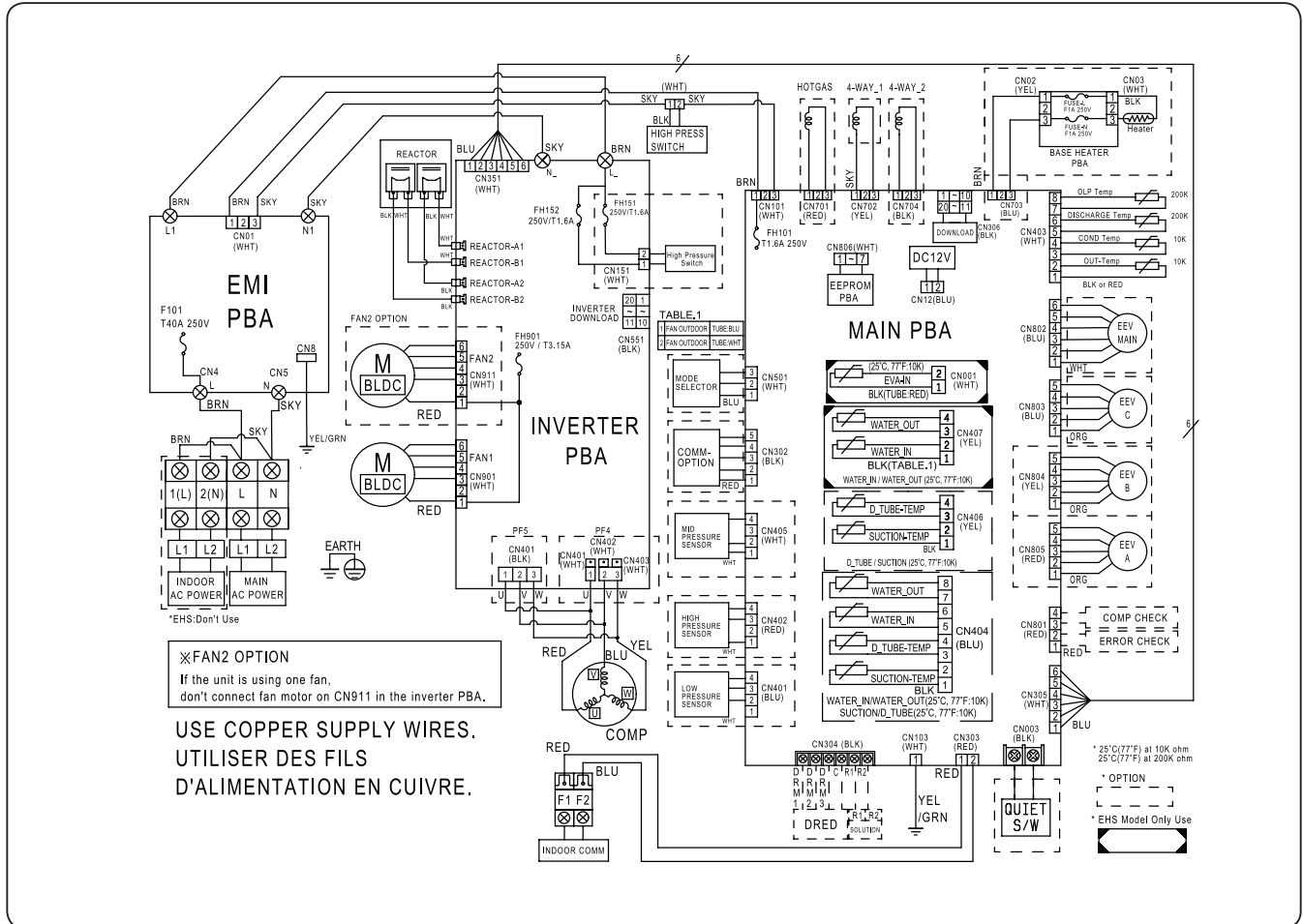

M BLDC	BLDC FAN MOTOR	COMP	COMPRESSOR
Comm	Communication	OUT-Temp	Thermistor OUT(10K)
COND-Temp	Thermistor COND(10K)	DISCHARGE-Temp	Thermistor DISCHARGE(200K)
OLP-Temp	Thermistor OLP(200K)	SUCTION-TEMP	Thermistor SUCTION(10K)

NOTES

1. This wiring diagram applies only to the Outdoor unit.
2. Symbols show as follow :
blk: black, red: red, blu: blue, wht: white, yel: yellow, brn: brown, sky: skyblue, grn: green
3. For connection wiring indoor-outdoor transmission F1-F2, indoor-wired remote controller transmission F3-F4.
4. (⊕) Protective earth(SCREW)

2. Outdoor Units

2-4. Electrical wiring diagram

AE080/120/160RXYDGG/EU

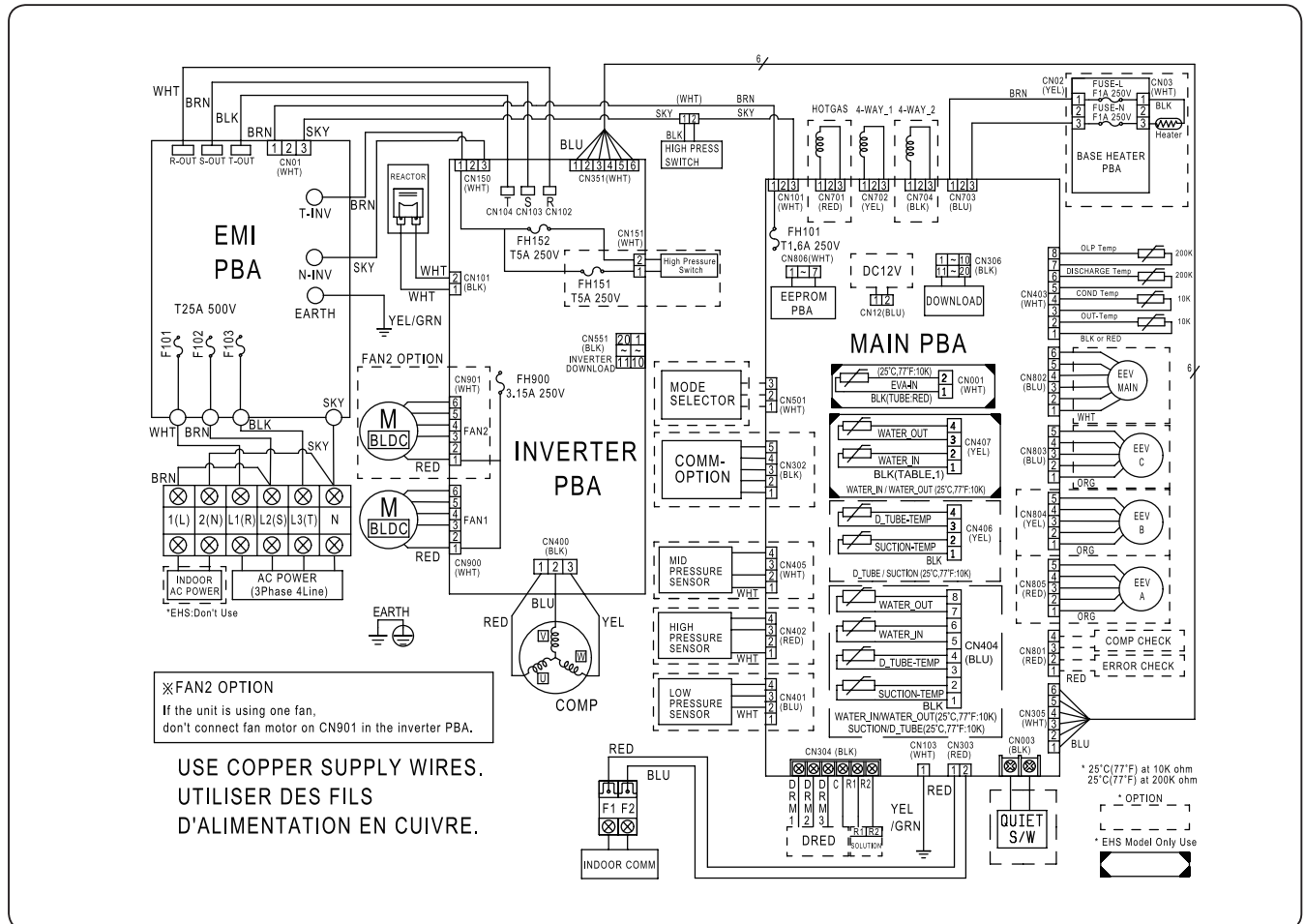

M BLDC	BLDC FAN MOTOR	COMP	COMPRESSOR
Comm	Communication	OUT-Temp	Thermistor OUT(10K)
COND-Temp	Thermistor COND(10K)	DISCHARGE-Temp	Thermistor DISCHARGE(200K)
OLP-Temp	Thermistor OLP(200K)	SUCTION-TEMP	Thermistor SUCTION(10K)

NOTES

1. This wiring diagram applies only to the Outdoor unit.
2. Symbols show as follow :
blk: black, red: red, blu: blue, wht: white, yel: yellow, brn: brown, sky: skyblue, grn: green
3. For connection wiring indoor-outdoor transmission F1-F2, indoor-wired remote controller transmission F3-F4.
4. ⊕ Protective earth(SCREW)

2. Outdoor Units

2-5. Sound data

Summary

Capacity (kW)	Model	Sound Pressure dB(A)		Sound Power dB(A)
		Cooling	Heating	Heating
5.0	AE050RXYDEG/EU	45	45	61
8.0	AE080RXYDEG/EU	48	48	63
12.0	AE120RXYDEG/EU	50	50	64
16.0	AE160RXYDEG/EU	54	52	66
8.0	AE080RXYDGG/EU	48	48	63
12.0	AE120RXYDGG/EU	50	50	64
16.0	AE160RXYDGG/EU	54	52	66

NOTE

- Specifications may be subject to change without prior notice.
- Sound Pressure Level
 - Sound pressure level is obtained in an anechoic room.
 - Sound pressure level is a relative value, depending on the distance and acoustic environment.
 - Sound pressure level may differ depending on operation condition.
 - dBA = A-weighted sound pressure level
 - Reference acoustic pressure 0 dB = 20 μ Pa
- Sound Power Level
 - Sound power level is an absolute value that a sound source generates.
 - dBA = A-weighted sound power level.
 - Reference power : 1pW.
 - Measured according to ISO 3741.

2. Outdoor Units

2-5. Sound data

Sound Pressure level

Unit: dB(A)

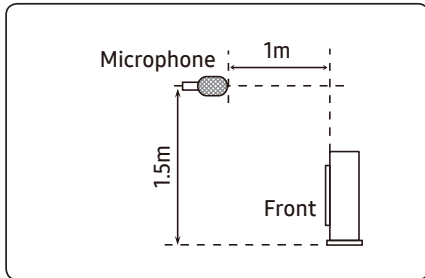

Model	Cooling	Heating
AE050RXYDEG/EU	45	45
AE080RXYDEG/EU	48	48
AE120RXYDEG/EU	50	50
AE160RXYDEG/EU	54	52

- NR Curve

1) AE050RXYDEG/EU

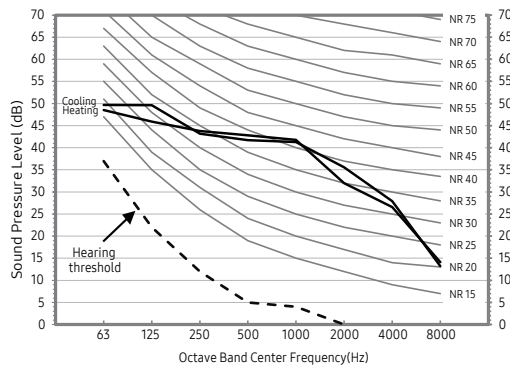

2) AE080RXYDEG/EU

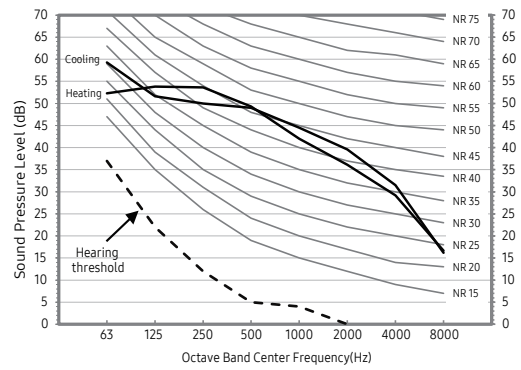

3) AE120RXYDEG/EU

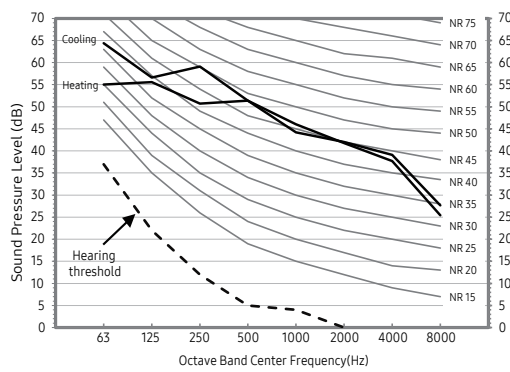

4) AE160RXYDEG/EU

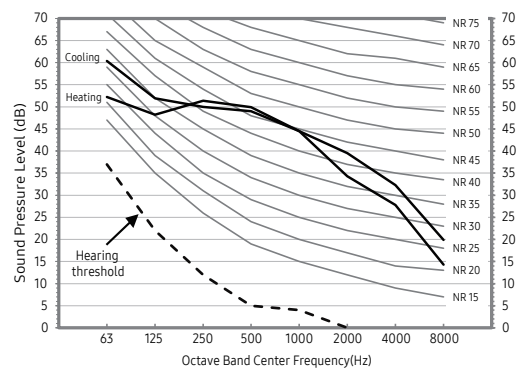

2. Outdoor Units

2-5. Sound data

Sound Pressure level

Unit: dB(A)

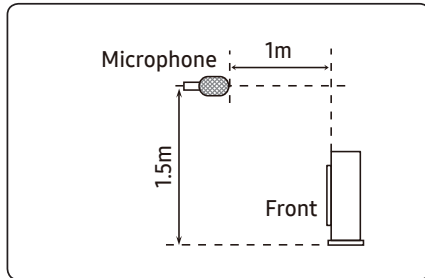

Model	Cooling	Heating
AE080RXYDGG/EU	48	48
AE120RXYDGG/EU	50	50
AE160RXYDGG/EU	54	52

- NR Curve

5) AE080RXYDGG/EU

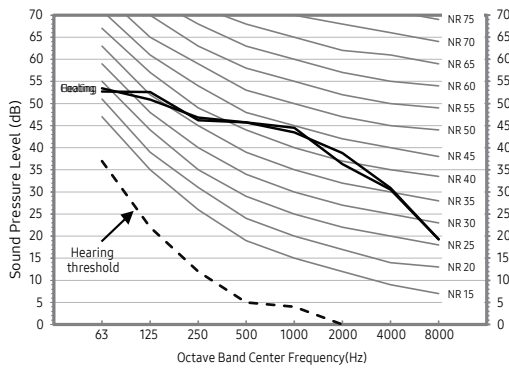

6) AE120RXYDGG/EU

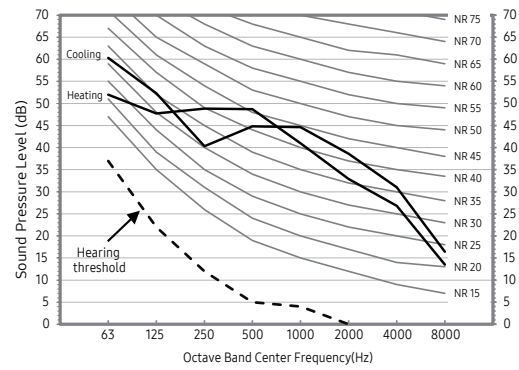

7) AE160RXYDGG/EU

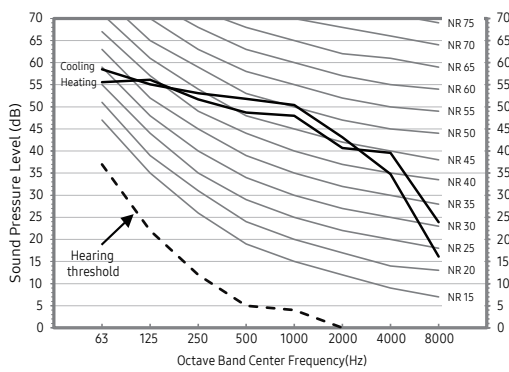

2. Outdoor Units

2-5. Sound data

Sound Power level

NOTE

- Specifications may be subject to change without prior notice
 - Sound power level is an absolute value that a sound source generates.
 - dBA = A-weighted sound power level.
 - Reference power : 1pW.
 - Measured according to ISO 3741.

Model	Power (dBA)
AE050RXYDEG/EU	61
AE080RXYDEG/EU	63
AE120RXYDEG/EU	64
AE160RXYDEG/EU	66

1) AE050RXYDEG/EU

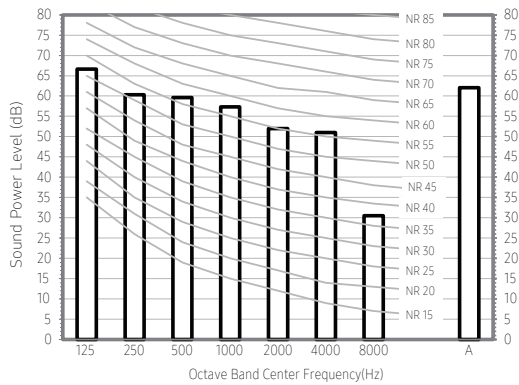

2) AE080RXYDEG/EU

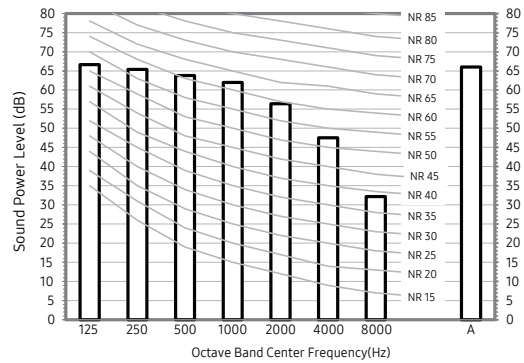

3) AE120RXYDEG/EU

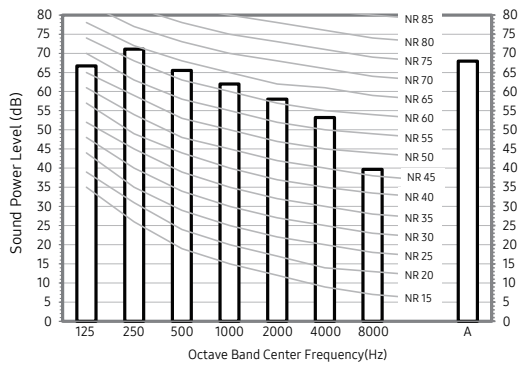

4) AE160RXYDEG/EU

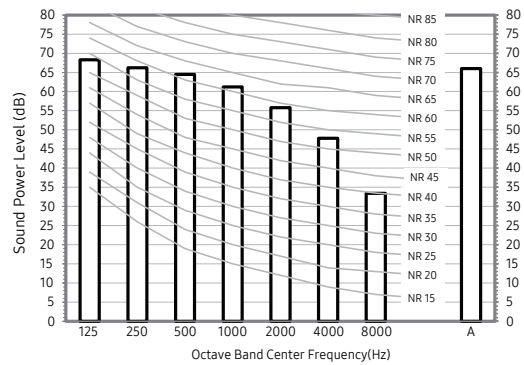

2. Outdoor Units

2-5. Sound data

Sound Power level

NOTE

- Specifications may be subject to change without prior notice
 - Sound power level is an absolute value that a sound source generates.
 - dBA = A-weighted sound power level.
 - Reference power : 1pW.
 - Measured according to ISO 3741.

Model	Power (dBA)
AE080RXYDGG/EU	63
AE120RXYDGG/EU	64
AE160RXYDGG/EU	66

5) AE080RXYDGG/EU

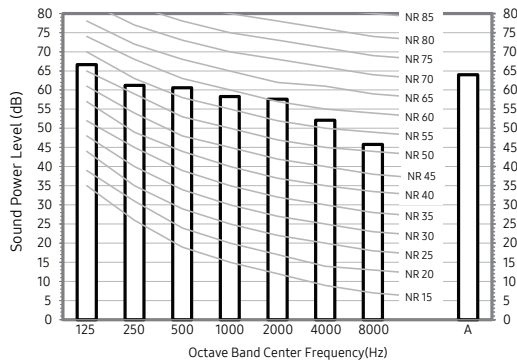

6) AE120RXYDGG/EU

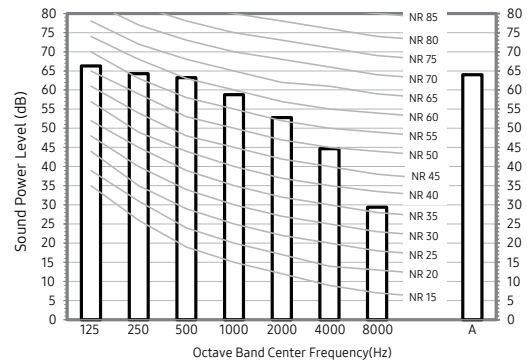

7) AE160RXYDGG/EU

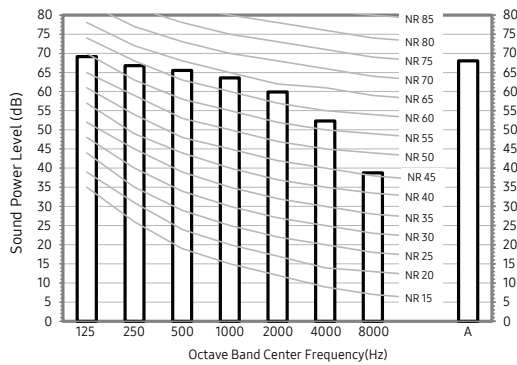

2. Outdoor Units

2-6. Operation range

1) Cooling

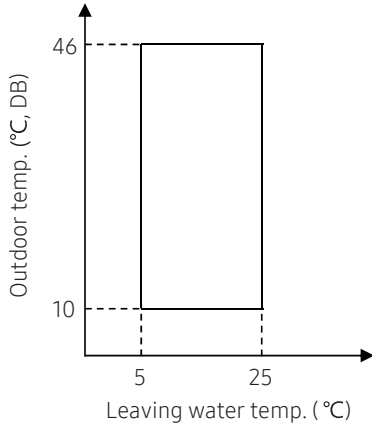

2) Heating

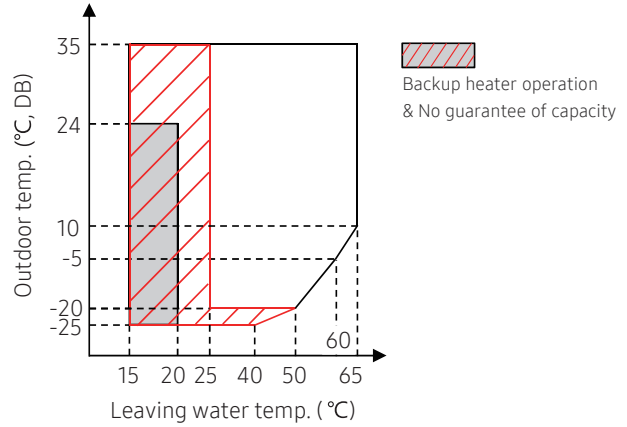

MONO Outdoor Unit		Water Temp. (°C)			Water Flow Rates (LPM)			Air Temp. (°C, DB/WB)		
		Min	Std	Max	Min	Std	Max	Min	Std	Max
Controller	Cooling	5	-	25						
	Heating	15	-	65						
Cooling	Inlet	-	23 (12 ^{*2})	30	12 (7 ^{*1})	Δ 5°C	58 (48 ^{*1})	10/-	35/24	46/28
	Outlet	5	18 (7 ^{*2})	25						
Heating	Inlet	5	30 (40 ^{*2})	-				-25/-	7/6	35/24
	Outlet	25 (15 ^{*3})	35 (45 ^{*2})	65						

*1) Model : AE050RXYDEG
AE080RXYDEG
AE080RXYDGG

*2) Eurovent Test Condition #2

*3) Back up heater operation.

※ Operation of outdoor unit possible, but no guarantee of capacity in this condition. (-25°C ≤ Outdoor temp < -20°C)

3) DHW (Domestic Hot Water Tank)

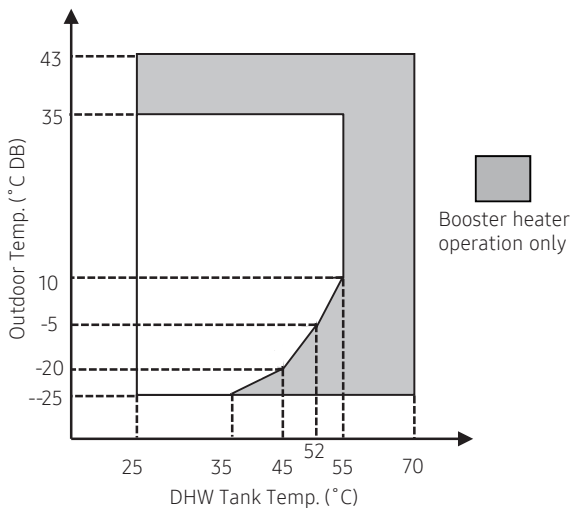

※ Special condition(35°C < Outdoor temp. ≤ 43°C) is operated by only Booster Heater.
SAMSUNG doesn't supply DHW for EHS Split.
Since it is a reference data, you have to check DHW operation range for yours.

2. Outdoor Units

2-7. Piping diagram

AE050/080RXD*G/EU

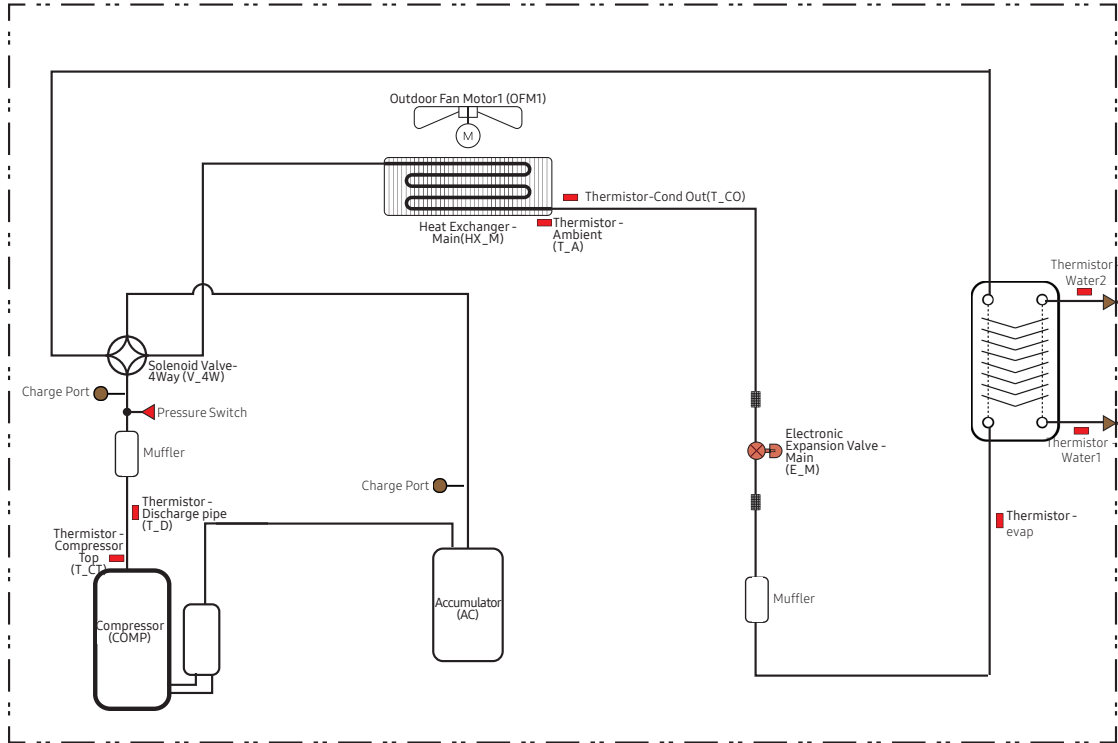

AE120/160RXD*G/EU

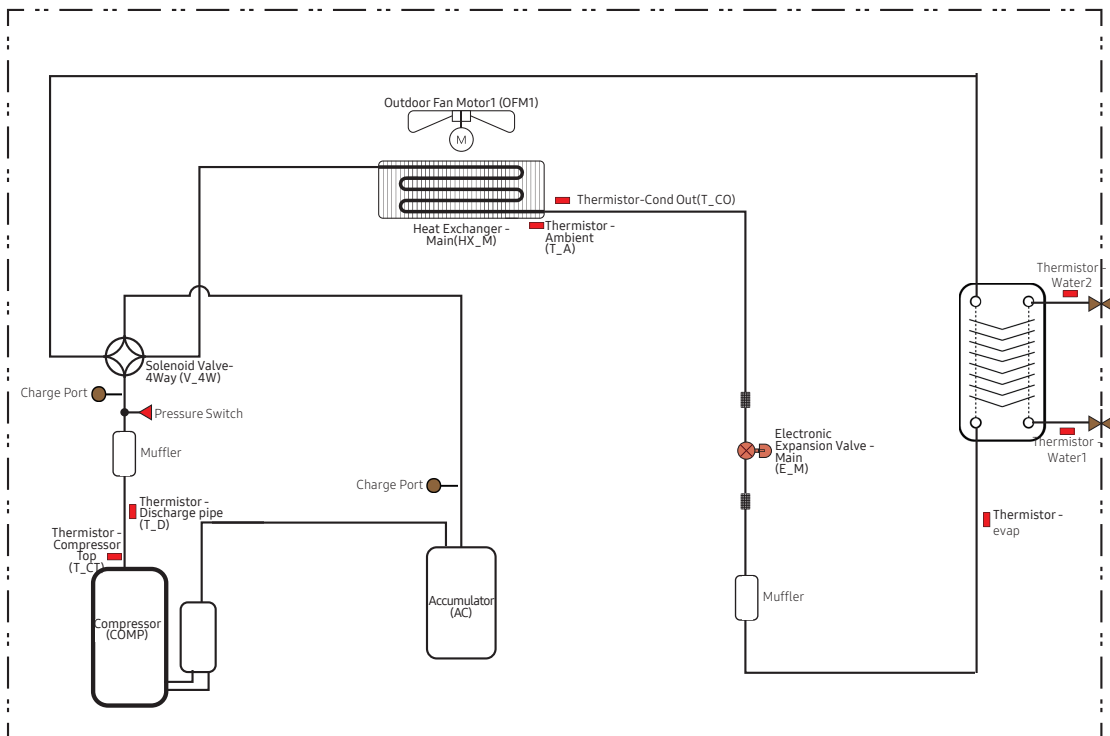

2. Outdoor Units

2-8. Capacity table

1) Maximum Heating Capacity (Peak Value)

LWT (Leaving Water Temp.), Tamb (Ambient Temp.), HC (Heating Capacity), PI (Power input)

Model	LWT(°C)	30		35		40		45		50		55		60		65		
	Tamb(°C)	HC(kW)	PI(kW)	HC(kW)	PI(kW)	HC(kW)	PI(kW)	HC(kW)	PI(kW)	HC(kW)	PI(kW)	HC(kW)	PI(kW)	HC(kW)	PI(kW)	HC(kW)	PI(kW)	
AE050RXYDEG	-20	3.57	1.50	3.40	1.66	3.41	1.71	3.43	1.98									
	-15	4.47	1.71	4.26	1.90	4.12	1.94	3.99	2.00	3.87	2.10							
	-10	5.25	1.73	5.00	1.94	4.85	2.00	4.70	2.08	4.56	2.20	4.23	2.44					
	-7	5.58	1.74	5.31	1.96	5.20	2.17	5.08	2.40	4.97	2.68	4.86	2.91					
	-2	5.91	1.68	5.63	1.89	5.41	2.08	5.20	2.26	4.94	2.54	4.68	2.77	4.43	3.05			
	2	5.86	1.50	5.58	1.69	5.27	1.78	4.97	1.83	4.72	2.02	4.47	2.15	4.23	2.35			
	7	5.25	0.92	5.00	1.03	4.90	1.22	4.80	1.30	4.55	1.55	4.30	1.52	4.08	1.79	3.85	1.84	
	10	5.62	0.95	5.35	1.07	5.27	1.21	5.24	1.38	4.98	1.55	4.72	1.80	4.48	1.86	4.29	1.97	
	15	6.22	0.99	5.92	1.11	5.87	1.23	5.93	1.42	5.64	1.60	5.45	1.81	5.18	1.87	4.95	1.94	
20	6.76	1.02	6.58	1.16	6.69	1.31	6.80	1.49	6.46	1.66	6.18	1.82	5.93	1.86	5.62	1.88		
AE080RXYD*G	-20	5.60	2.32	5.33	2.57	5.27	2.74	5.20	3.13									
	-15	6.56	2.54	6.25	2.82	6.15	2.98	6.06	3.16	5.88	3.32							
	-10	8.02	2.71	7.64	3.01	7.41	3.15	7.18	3.31	7.11	3.52	6.75	4.15					
	-7	8.04	2.80	7.80	2.95	7.43	3.25	7.27	3.40	7.15	3.73	6.80	4.01					
	-2	8.56	2.72	8.15	2.90	7.89	3.21	7.62	3.38	7.24	3.80	6.86	4.10	6.50	4.45			
	2	8.55	2.43	8.14	2.73	7.85	2.89	7.56	2.98	7.18	3.28	6.80	3.58	6.44	3.95			
	7	8.40	1.58	8.00	1.77	7.70	2.04	7.40	2.12	7.25	2.56	7.10	2.53	6.96	3.02	6.81	3.12	
	10	9.04	1.62	8.61	1.82	8.36	2.02	8.19	2.27	7.78	2.56	7.37	2.98	7.01	3.07	6.70	3.25	
	15	10.07	1.64	9.59	1.85	9.42	2.07	9.45	2.40	8.97	2.70	8.68	3.06	8.24	3.15	7.89	3.28	
20	11.02	1.67	10.73	1.89	10.85	2.20	10.98	2.55	10.43	2.84	9.98	3.13	9.58	3.20	9.07	3.24		
AE120RXYD*G	-20	9.82	4.36	9.35	4.81	9.04	4.91	8.72	4.88									
	-15	10.80	4.38	10.49	4.87	10.33	4.98	10.16	4.98	9.85	5.23							
	-10	12.39	4.32	12.20	4.88	11.65	5.04	11.46	5.23	11.39	5.49	11.37	5.72					
	-7	13.13	4.37	12.56	4.61	11.95	5.39	11.40	5.88	11.04	6.31	10.28	6.65					
	-2	13.60	4.05	12.95	4.55	12.72	5.09	12.48	5.62	12.25	6.32	11.83	7.02	11.14	7.80			
	2	13.19	3.42	12.75	3.84	12.41	4.39	12.21	4.94	12.07	5.56	11.53	6.18	10.93	6.56			
	7	12.60	2.57	12.00	2.65	11.85	3.06	11.70	3.18	11.50	3.46	11.30	3.73	11.11	4.06	10.48	4.53	
	10	13.91	2.55	12.98	2.76	12.79	3.03	12.61	3.26	11.98	3.67	11.35	4.16	11.00	4.45	10.42	4.71	
	15	16.09	2.51	15.02	2.72	14.76	2.93	14.51	3.19	13.79	3.59	13.06	4.03	12.66	4.19	11.99	4.48	
20	18.27	2.50	17.05	2.68	16.73	2.88	16.08	3.06	15.44	3.44	14.77	3.83	14.03	3.91	13.57	3.98		
AE160RXYD*G	-20	11.87	5.40	11.30	5.95	10.99	6.34	10.68	6.61									
	-15	13.24	5.50	12.87	6.12	12.66	6.50	12.44	6.74	12.07	7.08							
	-10	15.12	5.47	14.80	6.21	14.47	6.61	14.23	7.18	14.06	7.43	13.98	7.81					
	-7	15.97	5.56	15.65	6.03	15.27	7.05	14.91	7.84	14.36	7.72	13.60	7.91					
	-2	16.59	5.26	15.80	5.91	15.24	6.42	14.69	6.93	13.95	7.79	13.22	8.66	12.52	9.62			
	2	16.12	4.55	15.35	5.12	14.15	5.27	12.95	5.42	12.31	6.10	11.66	6.77	11.04	7.19			
	7	16.80	3.51	16.00	3.62	15.70	4.26	15.40	4.49	15.20	4.84	15.00	5.18	14.81	5.60	14.03	6.19	
	10	18.25	3.55	17.04	3.85	16.75	4.31	16.47	4.72	15.64	5.31	14.82	6.01	14.37	6.43	13.61	6.81	
	15	20.68	3.63	19.30	3.92	19.03	4.32	18.76	4.80	17.82	5.40	16.88	6.05	16.37	6.30	15.50	6.74	
20	23.10	3.73	21.56	4.00	21.31	4.42	20.62	4.78	19.79	5.38	18.95	5.98	18.00	6.11	17.40	6.23		

1. Heating capacity : Capacity is according to Eurovent rating standard OM-3-2015 and valid for heated water range $\Delta t = 3\sim 8^{\circ}\text{C}$
 2. Cooling capacity : Capacity is according to Eurovent rating standard OM-3-2015 and valid for chilled water range $\Delta t = 3\sim 8^{\circ}\text{C}$
 3. Power input : Power input is according to Eurovent rating standard OM-3-2015.
 4. Peak value : Tested without defrost operation in accordance with EN14511
- ※ The real capacity would be changed according to the install environment.

2. Outdoor Units

2-8. Capacity table

2) Maximum Heating Capacity (Integrated Value)

LWT (Leaving Water Temp.), Tamb (Ambient Temp.), HC (Heating Capacity), PI (Power input)

Model	LWT(°C) Tamb(°C)	30		35		40		45		50		55		60		65	
		HC(kW)	PI(kW)	HC(kW)	PI(kW)	HC(kW)	PI(kW)	HC(kW)	PI(kW)	HC(kW)	PI(kW)	HC(kW)	PI(kW)	HC(kW)	PI(kW)	HC(kW)	PI(kW)
AE050RXYDEG	-20	3.57	1.50	3.40	1.66	3.41	1.71	3.43	1.98								
	-15	4.47	1.71	4.26	1.90	4.12	1.94	3.99	2.00	3.87	2.10						
	-10	4.89	1.69	4.66	1.90	4.80	1.99	4.65	2.08	4.47	2.18	4.15	2.39				
	-7	5.09	1.67	4.90	1.69	5.04	2.12	4.93	2.36	4.78	2.58	4.67	2.79				
	-2	4.94	1.45	4.75	1.63	4.67	1.83	4.44	1.95	4.26	2.19	4.08	2.44	3.86	2.71		
	2	4.79	1.23	4.56	1.38	4.35	1.50	4.12	1.54	3.98	1.73	3.80	1.92	3.64	2.14		
	7	5.25	0.92	5.00	1.03	4.90	1.22	4.80	1.30	4.55	1.55	4.30	1.52	4.08	1.79	3.85	1.84
	10	5.62	0.95	5.35	1.07	5.27	1.21	5.24	1.38	4.98	1.55	4.72	1.80	4.48	1.86	4.29	1.97
	15	6.22	0.99	5.92	1.11	5.87	1.23	5.93	1.42	5.64	1.60	5.45	1.81	5.18	1.87	4.95	1.94
20	6.76	1.02	6.58	1.16	6.69	1.31	6.80	1.49	6.46	1.66	6.18	1.82	5.93	1.86	5.62	1.88	
AE080RXYD*G	-20	5.60	2.32	5.33	2.57	5.27	2.74	5.20	3.13								
	-15	6.56	2.54	6.25	2.82	6.15	2.98	6.06	3.16	5.88	3.32						
	-10	7.47	2.66	7.11	2.99	7.34	3.14	7.11	3.28	6.69	3.45	6.65	4.10				
	-7	7.33	2.69	7.06	2.72	7.20	3.17	6.98	3.32	6.93	3.73	6.00	3.97				
	-2	7.16	2.34	6.89	2.63	6.80	2.83	6.50	2.91	6.24	3.27	5.97	3.64	5.66	4.04		
	2	6.98	1.99	6.65	2.23	6.48	2.44	6.27	2.49	6.05	2.80	5.79	3.11	5.54	3.46		
	7	8.40	1.58	8.00	1.77	7.70	2.04	7.40	2.12	7.25	2.56	7.10	2.53	6.96	3.02	6.81	3.12
	10	9.04	1.62	8.61	1.82	8.36	2.02	8.19	2.27	7.78	2.56	7.37	2.98	7.01	3.07	6.70	3.25
	15	10.07	1.64	9.59	1.85	9.42	2.07	9.45	2.40	8.97	2.70	8.68	3.06	8.24	3.15	7.89	3.28
20	11.02	1.67	10.73	1.89	10.85	2.20	10.98	2.55	10.43	2.84	9.98	3.13	9.58	3.20	9.07	3.24	
AE120RXYD*G	-20	9.82	4.36	9.35	4.81	9.04	4.91	8.72	4.88								
	-15	10.80	4.38	10.49	4.87	10.33	4.98	10.16	4.98	9.85	5.23						
	-10	11.78	4.23	11.80	4.85	11.44	4.99	11.30	5.23	11.28	5.49	11.25	5.72				
	-7	11.97	4.19	11.64	4.33	11.07	5.18	10.50	5.64	10.61	6.11	10.07	6.57				
	-2	11.49	3.56	11.06	4.01	10.97	4.48	10.76	4.95	10.43	5.62	9.88	6.24	9.36	7.01		
	2	11.11	2.94	10.58	3.30	10.80	3.78	10.91	4.25	10.47	4.83	9.92	5.31	9.40	6.02		
	7	12.60	2.57	12.00	2.65	11.85	3.06	11.70	3.18	11.50	3.46	11.30	3.73	11.11	4.06	10.48	4.53
	10	13.91	2.55	12.98	2.76	12.79	3.03	12.61	3.26	11.98	3.67	11.35	4.16	11.00	4.45	10.42	4.71
	15	16.09	2.51	15.02	2.72	14.76	2.93	14.51	3.19	13.79	3.59	13.06	4.03	12.66	4.19	11.99	4.48
20	18.27	2.50	17.05	2.68	16.73	2.88	16.08	3.06	15.44	3.44	14.77	3.83	14.03	3.91	13.57	3.98	
AE160RXYD*G	-20	11.87	5.40	11.30	5.95	10.99	6.34	10.68	6.61								
	-15	13.24	5.50	12.87	6.12	12.66	6.50	12.44	6.74	12.07	7.08						
	-10	14.37	5.36	14.39	6.15	13.96	6.55	13.80	7.07	13.77	7.43	13.73	7.74				
	-7	14.56	5.34	14.16	5.52	14.14	6.77	14.12	7.53	14.06	7.64	13.12	7.75				
	-2	14.01	4.63	13.48	5.20	13.14	5.65	12.67	6.10	12.28	6.93	11.63	7.69	11.02	8.63		
	2	13.58	3.92	12.94	4.40	12.05	4.53	11.03	4.66	10.58	5.29	10.03	5.83	9.50	6.60		
	7	16.80	3.51	16.00	3.62	15.70	4.26	15.40	4.49	15.20	4.84	15.00	5.18	14.81	5.60	14.03	6.19
	10	18.25	3.55	17.04	3.85	16.75	4.31	16.47	4.72	15.64	5.31	14.82	6.01	14.37	6.43	13.61	6.81
	15	20.68	3.63	19.30	3.92	19.03	4.32	18.76	4.80	17.82	5.40	16.88	6.05	16.37	6.30	15.50	6.74
20	23.10	3.73	21.56	4.00	21.31	4.42	20.62	4.78	19.79	5.38	18.95	5.98	18.00	6.11	17.40	6.23	

1. Heating capacity : Capacity is according to Eurovent rating standard OM-3-2015 and valid for heated water range $\Delta t = 3\sim 8^{\circ}\text{C}$
 2. Cooling capacity : Capacity is according to Eurovent rating standard OM-3-2015 and valid for chilled water range $\Delta t = 3\sim 8^{\circ}\text{C}$
 3. Power input : Power input is according to Eurovent rating standard OM-3-2015.
 4. Peak value : Tested without defrost operation in accordance with EN14511
- ※ The real capacity would be changed according to the install environment.

2. Outdoor Units

2-8. Capacity table

3) Cooling Capacity

LWT (Leaving Water Temp.), Tamb (Ambient Temp.), CC (Cooling Capacity), PI (Power input)

	LWT(°C)	7		10		13		15		18		25	
	Tamb(°C)	CC(kW)	PI(kW)	CC(kW)	PI(kW)	CC(kW)	PI(kW)	CC(kW)	PI(kW)	CC(kW)	PI(kW)	CC(kW)	PI(kW)
AE050RXYDEG	10	4.32	0.86	4.62	0.85	4.93	0.85	5.23	0.85	5.54	0.85	6.09	0.87
	20	4.15	0.97	4.45	0.97	4.74	0.97	5.03	0.97	5.33	0.96	5.86	0.98
	30	3.99	1.09	4.27	1.08	4.55	1.08	4.83	1.08	5.11	1.08	5.62	1.10
	35	3.90	1.15	4.18	1.15	4.45	1.15	4.73	1.14	5.00	1.14	5.50	1.16
	46	3.72	1.27	3.98	1.27	4.24	1.27	4.50	1.26	4.77	1.26	5.24	1.28
	AE080RXYD*G	10	6.31	1.40	6.92	1.33	7.53	1.26	8.14	1.19	8.75	1.12	9.62
20		6.07	1.59	6.66	1.51	7.24	1.43	7.83	1.35	8.41	1.27	9.25	1.29
30		5.83	1.78	6.39	1.69	6.95	1.60	7.51	1.51	8.07	1.42	8.88	1.45
35		5.70	1.88	6.25	1.79	6.80	1.69	7.35	1.60	7.90	1.50	8.69	1.53
46		5.43	2.08	5.96	1.97	6.48	1.87	7.00	1.76	7.53	1.66	8.28	1.69
AE120RXYD*G		10	9.96	2.03	10.79	2.04	11.62	2.05	12.45	2.06	13.28	2.06	14.61
	20	9.59	2.31	10.38	2.32	11.18	2.32	11.98	2.33	12.78	2.34	14.06	2.39
	30	9.20	2.58	9.96	2.59	10.73	2.60	11.50	2.61	12.26	2.62	13.49	2.67
	35	9.00	2.73	9.75	2.74	10.50	2.75	11.25	2.76	12.00	2.77	13.20	2.83
	46	8.58	3.02	9.29	3.03	10.01	3.04	10.72	3.05	11.44	3.06	12.58	3.12
	AE160RXYD*G	10	11.51	2.45	12.51	2.45	13.51	2.45	14.50	2.45	15.50	2.44	17.05
20		11.08	2.78	12.03	2.78	12.99	2.78	13.95	2.77	14.91	2.77	16.40	2.83
30		10.63	3.11	11.55	3.11	12.47	3.10	13.39	3.10	14.31	3.10	15.74	3.16
35		10.40	3.29	11.30	3.29	12.20	3.29	13.10	3.28	14.00	3.28	15.40	3.35
46		9.91	3.64	10.77	3.63	11.63	3.63	12.48	3.63	13.34	3.62	14.68	3.70

1. Heating capacity : Capacity is according to Eurovent rating standard OM-3-2015 and valid for heated water range $\Delta t = 3\sim 8^{\circ}\text{C}$
 2. Cooling capacity : Capacity is according to Eurovent rating standard OM-3-2015 and valid for chilled water range $\Delta t = 3\sim 8^{\circ}\text{C}$
 3. Power input : Power input is according to Eurovent rating standard OM-3-2015.
- ※ The real capacity would be changed according to the install environment.

2. Outdoor Units

2-9. Silent mode corrections

Heating

Silent Function	Outdoor Air Temperature(°C DB)			
	-15	2	7	15
Level 1	0.92	0.87	0.94	0.94
Level 2	0.82	0.78	0.84	0.84
Level 3	0.68	0.64	0.69	0.69
Low-noise	0.7	0.6	0.69	0.69

Heating

Silent Function	Outdoor Air Temperature(°C DB)			
	10	20	35	45
Level 1	1	1	0.92	0.92
Level 2	0.98	0.89	0.83	0.83
Level 3	0.81	0.74	0.68	0.68

3. Tank integrated hydro unit

3-1. Specifications

Model Name		Indoor Unit		AE200RNWMEG/EU	AE200RNWMEG/EU	AE200RNWMEG/EU	
		Outdoor Unit		AE050RXYDEG/EU	AE080RXYDEG/EU	AE120RXYDEG/EU	
Mode		-		Heat Pump (A2W)	Heat Pump (A2W)	Heat Pump (A2W)	
Power Supply		Φ, #, V, Hz		1,2,220-240,50	1,2,220-240,50	1,2,220-240,50	
Power input	Cooling (Nominal)	kW		0.2	0.2	0.2	
	Heating (Nominal)	kW		0.2	0.2	0.2	
	Cooling (Max)	kW		0.2	0.2	0.2	
	Heating (Max)	kW		5.2	5.2	5.2	
Current Input	Cooling (Nominal)	A		0.9	0.9	0.9	
	Heating (Nominal)	A		0.9	0.9	0.9	
	Cooling (Max)	A		0.9	0.9	0.9	
	Heating (Max)	A		22.7	22.7	22.7	
Field Wiring	MCA	A		22.7	22.7	22.7	
	MFA			28.4	28.4	28.4	
Heating up time		h /min		2 / 20	2 / 0	1 / 30	
Water Heating	Declared load profile	-		L	L	L	
	Energy efficiency Class	-		A+	A+	A	
Water Connections	Water Flow Rate (Std)[H/C]		LPM	14.4/14.4	23.1/21.6	34.6/34.6	
	Water Pressure (Max)		bar	3	3	3	
	Water pipe (To outdoor unit)	Type	-		Straight pipe	Straight pipe	Straight pipe
		Inlet	Φ, mm		28	28	28
		Outlet	Φ, mm		28	28	28
	Water pipe (Space heating)	Type	-		Straight pipe	Straight pipe	Straight pipe
		Inlet	Φ, mm		28	28	28
		Outlet	Φ, mm		28	28	28
	Water pipe (DHW)	Type	-		Straight pipe	Straight pipe	Straight pipe
		Inlet	Φ, mm		22	22	22
		Outlet	Φ, mm		22	22	22
	Water pipe (Secondary water return, Only 260L)	Type	-		-	-	-
		Inlet	Φ, mm		-	-	-
	Leaving Water Temperature	Heating	°C		15~65	15~65	15~65
Cooling		°C		5~25	5~25	5~25	
DHW Tank	Nominal Water Volume		liter	200	200	200	
	Net Water Volume		liter	194	194	194	
	Material		-	SUS 316L	SUS 316L	SUS 316L	
	Max. water pressure		bar	10	10	10	
	Max. water temperature		°C	70	70	70	
	Immersion heater		kW	3 (230V)	3 (230V)	3 (230V)	
	Insulation (h)		-	PU Foam	PU Foam	PU Foam	
Water Pump	Type		-	Centrifurugal (UPMM 25-9.5)	Centrifurugal (UPMM 25-9.5)	Centrifurugal (UPMM 25-9.5)	
	Motor Input		W	100	100	100	
	Number of Unit		EA	1	1	1	
Backup Heater	Power		kW	2 (230V)	2 (230V)	2 (230V)	
Safety device	Pressure relief valve		bar	2.9	2.9	2.9	
	Flow Sensor		LPM	5~60	5~60	5~60	
	Temperature & Pressure relief valve		bar, °C	7, 90	7, 90	7, 90	
	Thermostat (for immersion heater)		°C	49~82±5 (Auto, On : 15°C±3°C _↓)	49~82±5 (Auto, On : 15°C±3°C _↓)	49~82±5 (Auto, On : 15°C±3°C _↓)	
Expansion vessel	Internal water volume		liter	8	8	8	
	Working pressure		MPa	0.3	0.3	0.3	

3. Tank integrated hydro unit

3-1. Specifications

Model Name		Indoor Unit		AE200RNWMEG/EU	AE200RNWMEG/EU	AE200RNWMEG/EU		
		Outdoor Unit		AE050RXYDEG/EU	AE080RXYDEG/EU	AE120RXYDEG/EU		
Water Pump (Primary)	Type			-	BLDC Inv	BLDC Inv	BLDC Inv	
	Max static pressure			mAq	9.5	9.5	9.5	
Water Heat Exchanger	Type			-	Braszed Plate Exchager	Braszed Plate Exchager	Braszed Plate Exchager	
	Quantity			EA	1	1	1	
	Internal water volume			L	1.01(Water Side) 0.98(Refrigerant Side)	1.01(Water Side) 0.98(Refrigerant Side)	1.01(Water Side) 0.98(Refrigerant Side)	
	Water flow rate	Min.			l/min	7	7	12
		Max.			l/min	48	48	58
Insulation material			-	PE-FOAM	PE-FOAM	PE-FOAM		
IP Class			-	IPX1	IPX1	IPX1		
Air Purge Valve			Φ, inch	BSPP male 3/8"	BSPP male 3/8"	BSPP male 3/8"		
Sound	Sound Pressure	Heating			dB(A)	26	26	30
		Cooling			dB(A)	26	26	30
	Sound Power	Heating			dB(A)	40	40	44
Casing	Color			-	Earth brown	Earth brown	Earth brown	
	Material			-	Poweder coated Galvanised steel	Poweder coated Electro galvanized steel	Poweder coated Electro galvanized steel	
Packing	Material			-	EPS/BOX	EPS/BOX	EPS/BOX	
	Packing Weight			kg	12.0	12.0	12.0	
External Dimension	Net Weight			kg	130.0	130.0	130.0	
	Shipping Weight			kg	142.0	142.0	142.0	
	Net Dimensions (WxHxD)			mm	595 x 1,800 x 700	595 x 1,800 x 700	595 x 1,800 x 700	
	Shipping Dimensions (WxHxD)			mm	700 x 2,000 x 780	700 x 2,000 x 780	700 x 2,000 x 780	

NOTE

- Specifications may be subject to change without prior notice.

3. Tank integrated hydro unit

3-1. Specifications

Model Name		Indoor Unit		AE200RNWMEG/EU	AE260RNWMEG/EU	AE260RNWMEG/EU	
		Outdoor Unit		AE160RXYDEG/EU	AE080RXYDEG/EU	AE120RXYDEG/EU	
Mode		-		Heat Pump (A2W)	Heat Pump (A2W)	Heat Pump (A2W)	
Power Supply		Φ, #, V, Hz		1,2,220-240,50	1,2,220-240,50	1,2,220-240,50	
Power input	Cooling (Nominal)	kW		0.2	0.2	0.2	
	Heating (Nominal)	kW		0.2	0.2	0.2	
	Cooling (Max)	kW		0.2	0.2	0.2	
	Heating (Max)	kW		5.2	5.2	5.2	
Current Input	Cooling (Nominal)	A		0.9	0.9	0.9	
	Heating (Nominal)	A		0.9	0.9	0.9	
	Cooling (Max)	A		0.9	0.9	0.9	
	Heating (Max)	A		22.7	22.7	22.7	
Field Wiring	MCA	A		22.7	22.7	22.7	
	MFA			28.4	28.4	28.4	
Heating up time		h /min		1 / 30	2 / 25	1 / 50	
Water Heating	Declared load profile	-		L	XL	XL	
	Energy efficiency Class	-		A	A+	A	
Water Connections	Water Flow Rate (Std)[H/C]		LPM	46.2/40.4	23.1/21.6	34.6/34.6	
	Water Pressure (Max)		bar	3	3	3	
	Water pipe (To outdoor unit)	Type	-		Straight pipe	Straight pipe	Straight pipe
		Inlet	Φ, mm		28	28	28
		Outlet	Φ, mm		28	28	28
	Water pipe (Space heating)	Type	-		Straight pipe	Straight pipe	Straight pipe
		Inlet	Φ, mm		28	28	28
		Outlet	Φ, mm		28	28	28
	Water pipe (DHW)	Type	-		Straight pipe	Straight pipe	Straight pipe
		Inlet	Φ, mm		22	22	22
		Outlet	Φ, mm		22	22	22
	Water pipe (Secondary water return, Only 260L)	Type	-		-	Straight pipe	Straight pipe
		Inlet	Φ, mm		-	22	22
	Leaving Water Temperature	Heating	°C		15~65	15~65	15~65
Cooling		°C		5~25	5~25	5~25	
DHW Tank	Nominal Water Volume		liter	200	260	260	
	Net Water Volume		liter	194	254	254	
	Material		-	SUS 316L	SUS 316L	SUS 316L	
	Max. water pressure		bar	10	10	10	
	Max. water temperature		°C	70	70	70	
	Immersion heater		kW	3 (230V)	3 (230V)	3 (230V)	
	Insulation (h)		-	PU Foam	PU Foam	PU Foam	
Water Pump	Type		-	Centrifurugal (UPMM 25-9.5)	Centrifurugal (UPMM 25-9.5)	Centrifurugal (UPMM 25-9.5)	
	Motor Input		W	100	100	100	
	Number of Unit		EA	1	1	1	
Backup Heater	Power		kW	2 (230V)	2 (230V)	2 (230V)	
Safety device	Pressure relief valve		bar	2.9	2.9	2.9	
	Flow Sensor		LPM	5~60	5~60	5~60	
	Temperature & Pressure relief valve		bar, °C	7, 90	7, 90	7, 90	
	Thermostat (for immersion heater)		°C	49~82±5 (Auto, On : 15°C±3°C↓)	49~82±5 (Auto, On : 15°C±3°C↓)	49~82±5 (Auto, On : 15°C±3°C↓)	
Expansion vessel	Internal water volume		liter	8	8	8	
	Working pressure		MPa	0.3	0.3	0.3	

3. Tank integrated hydro unit

3-1. Specifications

Model Name		Indoor Unit		AE200RNWMEG/EU	AE260RNWMEG/EU	AE260RNWMEG/EU	
		Outdoor Unit		AE160RXYDEG/EU	AE080RXYDEG/EU	AE120RXYDEG/EU	
Water Pump (Primary)	Type			BLDC Inv	BLDC Inv	BLDC Inv	
	Max static pressure	mAq		9.5	9.5	9.5	
Water Heat Exchanger	Type			Braszed Plate Exchager	Braszed Plate Exchager	Braszed Plate Exchager	
	Quantity	EA		1	1	1	
	Internal water volume	L		1.01(Water Side) 0.98(Refrigerant Side)	1.01(Water Side) 0.98(Refrigerant Side)	1.01(Water Side) 0.98(Refrigerant Side)	
	Water flow rate	Min.	l/min		12	7	12
		Max.	l/min		58	48	58
Insulation material			PE-FOAM	PE-FOAM	PE-FOAM		
IP Class			IPX1	IPX1	IPX1		
Air Purge Valve			Φ, inch	BSPP male 3/8"	BSPP male 3/8"	BSPP male 3/8"	
Sound	Sound Pressure	Heating	dB(A)	30	26	30	
		Cooling	dB(A)	30	26	30	
	Sound Power	Heating	dB(A)	44	40	44	
Casing	Color			Earth brown	Earth brown	Earth brown	
	Material			Poweder coated Electro galvanized steel	Poweder coated Electro galvanized steel	Poweder coated Electro galvanized steel	
Packing	Material			EPS/BOX	EPS/BOX	EPS/BOX	
	Packing Weight	kg		12.0	12.0	12.0	
External Dimension	Net Weight	kg		130.0	140.0	140.0	
	Shipping Weight	kg		142.0	152.0	152.0	
	Net Dimensions (WxHxD)	mm		595 x 1,800 x 700	595 x 1,800 x 700	595 x 1,800 x 700	
	Shipping Dimensions (WxHxD)	mm		700 x 2,000 x 780	700 x 2,000 x 780	700 x 2,000 x 780	

NOTE

- Specifications may be subject to change without prior notice.

3. Tank integrated hydro unit

3-1. Specifications

Model Name		Indoor Unit		AE260RNWMEG/EU	AE260RNWMGG/EU	AE260RNWMGG/EU	AE260RNWMGG/EU	
		Outdoor Unit		AE160RXYDEG/EU	AE080RXYDGG/EU	AE120RXYDGG/EU	AE160RXYDGG/EU	
Mode		-		Heat Pump (A2W)	Heat Pump (A2W)	Heat Pump (A2W)	Heat Pump (A2W)	
Power Supply		Φ, #, V, Hz		1,2,220-240,50	1,2,220-240,50 3,4,380-415,50	1,2,220-240,50 3,4,380-415,50	1,2,220-240,50 3,4,380-415,50	
Power input	Cooling (Nominal)	kW		0.2	3Φ - / 1Φ 0.20	3Φ - / 1Φ 0.20	3Φ - / 1Φ 0.20	
	Heating (Nominal)	kW		0.2	3Φ - / 1Φ 0.20	3Φ - / 1Φ 0.20	3Φ - / 1Φ 0.20	
	Cooling (Max)	kW		0.2	3Φ - / 1Φ 0.20	3Φ - / 1Φ 0.20	3Φ - / 1Φ 0.20	
	Heating (Max)	kW		5.2	3Φ 6.00 / 1Φ 3.20	3Φ 6.00 / 1Φ 3.20	3Φ 6.00 / 1Φ 3.20	
Current Input	Cooling (Nominal)	A		0.9	3Φ - / 1Φ 0.9	3Φ - / 1Φ 0.9	3Φ - / 1Φ 0.9	
	Heating (Nominal)	A		0.9	3Φ - / 1Φ 0.9	3Φ - / 1Φ 0.9	3Φ - / 1Φ 0.9	
	Cooling (Max)	A		0.9	3Φ - / 1Φ 0.9	3Φ - / 1Φ 0.9	3Φ - / 1Φ 0.9	
	Heating (Max)	A		22.7	3Φ 8.7 / 1Φ 14.0	3Φ 8.7 / 1Φ 14.0	3Φ 8.7 / 1Φ 14.0	
Field Wiring	MCA	A		22.7	3Φ 8.7 / 1Φ 14.0	3Φ 8.7 / 1Φ 14.0	3Φ 8.7 / 1Φ 14.0	
	MFA			28.4	3Φ 10.9 / 1Φ 17.5	3Φ 10.9 / 1Φ 17.5	3Φ 10.9 / 1Φ 17.5	
Heating up time		h / min		1 / 50	2 / 25	1 / 50	1 / 50	
Water Heating	Declared load profile	-		XL	XL	XL	XL	
	Energy efficiency Class	-		A	A+	A	A	
Water Connections	Water Flow Rate (Std)[H/C]		LPM	46.2/40.4	23.1/21.6	34.6/34.6	46.2/40.4	
	Water Pressure (Max)		bar	3	3	3	3	
	Water pipe (To outdoor unit)	Type	-		Straight pipe	Straight pipe	Straight pipe	Straight pipe
		Inlet	Φ, mm		28	28	28	28
		Outlet	Φ, mm		28	28	28	28
	Water pipe (Space heating)	Type	-		Straight pipe	Straight pipe	Straight pipe	Straight pipe
		Inlet	Φ, mm		28	28	28	28
		Outlet	Φ, mm		28	28	28	28
	Water pipe (DHW)	Type	-		Straight pipe	Straight pipe	Straight pipe	Straight pipe
		Inlet	Φ, mm		22	22	22	22
		Outlet	Φ, mm		22	22	22	22
	Water pipe (Secondary water return, Only 260L)	Type	-		Straight pipe	Straight pipe	Straight pipe	Straight pipe
		Inlet	Φ, mm		22	22	22	22
	Leaving Water Temperature	Heating	°C		15~65	15~65	15~65	15~65
Cooling		°C		5~25	5~25	5~25	5~25	
DHW Tank	Nominal Water Volume		liter	260	260	260	260	
	Net Water Volume		liter	254	254	254	254	
	Material		-	SUS 316L	SUS 316L	SUS 316L	SUS 316L	
	Max. water pressure		bar	10	10	10	10	
	Max. water temperature		°C	70	70	70	70	
	Immersion heater		kW	3 (230V)	3 (230V)	3 (230V)	3 (230V)	
	Insulation (h)		-	PU Foam	PU Foam	PU Foam	PU Foam	
Water Pump	Type	-		Centrifurugal (UPMM 25-9.5)	Centrifurugal (UPMM 25-9.5)	Centrifurugal (UPMM 25-9.5)	Centrifurugal (UPMM 25-9.5)	
	Motor Input	W		100	100	100	100	
	Number of Unit	EA		1	1	1	1	
Backup Heater	Power	kW		2 (230V)	6 (3Φ 400V)	6 (3Φ 400V)	6 (3Φ 400V)	
Safety device	Pressure relief valve		bar	2.9	2.9	2.9	2.9	
	Flow Sensor		LPM	5~60	5~60	5~60	5~60	
	Temperature & Pressure relief valve		bar, °C	7, 90	7, 90	7, 90	7, 90	
	Thermostat (for immersion heater)		°C	49~82±5 (Auto, On : 15°C±3°C↓)	49~82±5 (Auto, On : 15°C±3°C↓)	49~82±5 (Auto, On : 15°C±3°C↓)	49~82±5 (Auto, On : 15°C±3°C↓)	
Expansion vessel	Internal water volume		liter	8	8	8	8	
	Working pressure		MPa	0.3	0.3	0.3	0.3	

3. Tank integrated hydro unit

3-1. Specifications

Model Name		Indoor Unit		AE260RNWMEG/EU	AE260RNWMGG/EU	AE260RNWMGG/EU	AE260RNWMGG/EU		
		Outdoor Unit		AE160RXYDEG/EU	AE080RXYDGG/EU	AE120RXYDGG/EU	AE160RXYDGG/EU		
Water Pump (Primary)	Type			-	BLDC Inv	BLDC Inv	BLDC Inv	BLDC Inv	
	Max static pressure			mAq	9.5	9.5	9.5	9.5	
Water Heat Exchanger	Type			-	Braszed Plate Exchanger	Braszed Plate Exchanger	Braszed Plate Exchanger	Braszed Plate Exchanger	
	Quantity			EA	1	1	1	1	
	Internal water volume			L	1.01(Water Side) 0.98(Refrigerant Side)	1.01(Water Side) 0.98(Refrigerant Side)	1.01(Water Side) 0.98(Refrigerant Side)	1.01(Water Side) 0.98(Refrigerant Side)	
	Water flow rate	Min.			l/min	12	7	12	12
		Max.			l/min	58	48	58	58
Insulation material			-	PE-FOAM	PE-FOAM	PE-FOAM	PE-FOAM		
IP Class				-	IPX1	IPX1	IPX1	IPX1	
Air Purge Valve				Φ, inch	BSPP male 3/8"	BSPP male 3/8"	BSPP male 3/8"	BSPP male 3/8"	
Sound	Sound Pressure	Heating			dB(A)	30	26	30	30
		Cooling			dB(A)	30	26	30	30
	Sound Power	Heating			dB(A)	44	40	44	44
Casing	Color			-	Earth brown	Earth brown	Earth brown	Earth brown	
	Material			-	Poweder coated Electro galvanized steel	Poweder coated Electro galvanized steel	Poweder coated Electro galvanized steel	Poweder coated Electro galvanized steel	
Packing	Material			-	EPS/BOX	EPS/BOX	EPS/BOX	EPS/BOX	
	Packing Weight			kg	12.0	12.0	12.0	12.0	
External Dimension	Net Weight			kg	140.0	140.0	140.0	140.0	
	Shipping Weight			kg	152.0	152.0	152.0	152.0	
	Net Dimensions (WxHxD)			mm	595 x 1,800 x 700	595 x 1,800 x 700	595 x 1,800 x 700	595 x 1,800 x 700	
	Shipping Dimensions (WxHxD)			mm	700 x 2,000 x 780	700 x 2,000 x 780	700 x 2,000 x 780	700 x 2,000 x 780	

NOTE

- Specifications may be subject to change without prior notice.

3. Tank integrated hydro unit

3-2. Dimensional drawing

AE200/260RNW**G/EU

Unit : mm

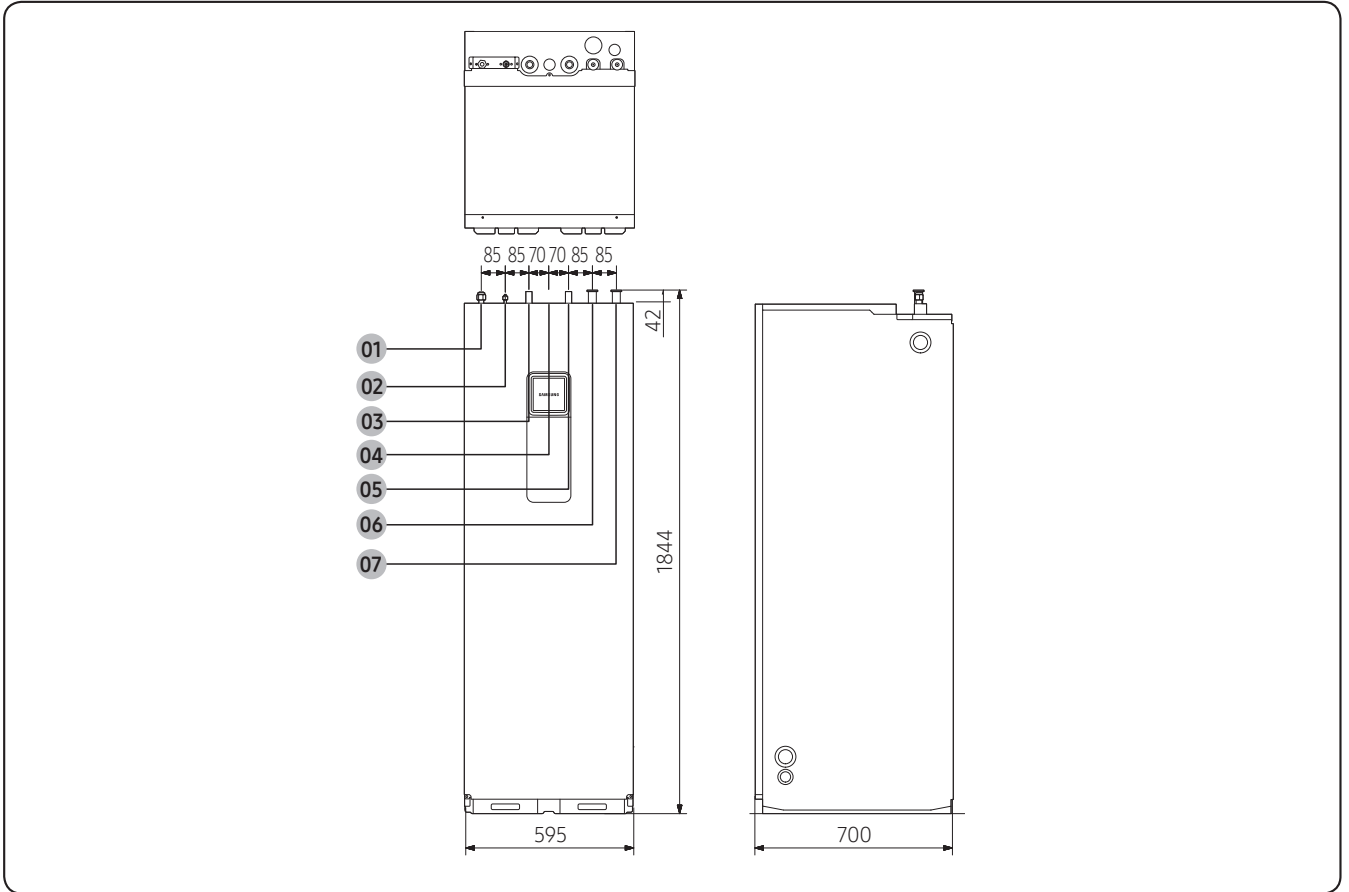

NO	Name	Description
01	Mono outdoor outlet	Ø28, T1.2
02	Mono outdoor inlet	Ø28, T1.2
03	Hot water outlet	Ø22, T1.0
04	Secondary return (260L option)	Ø22, T1.0
05	Cold water inlet	Ø22, T1.0
06	Space heating outlet	Ø28, T1.2
07	Space heating inlet	Ø28, T1.2

3. Tank integrated hydro unit

3-2. Dimensional drawing

Main components

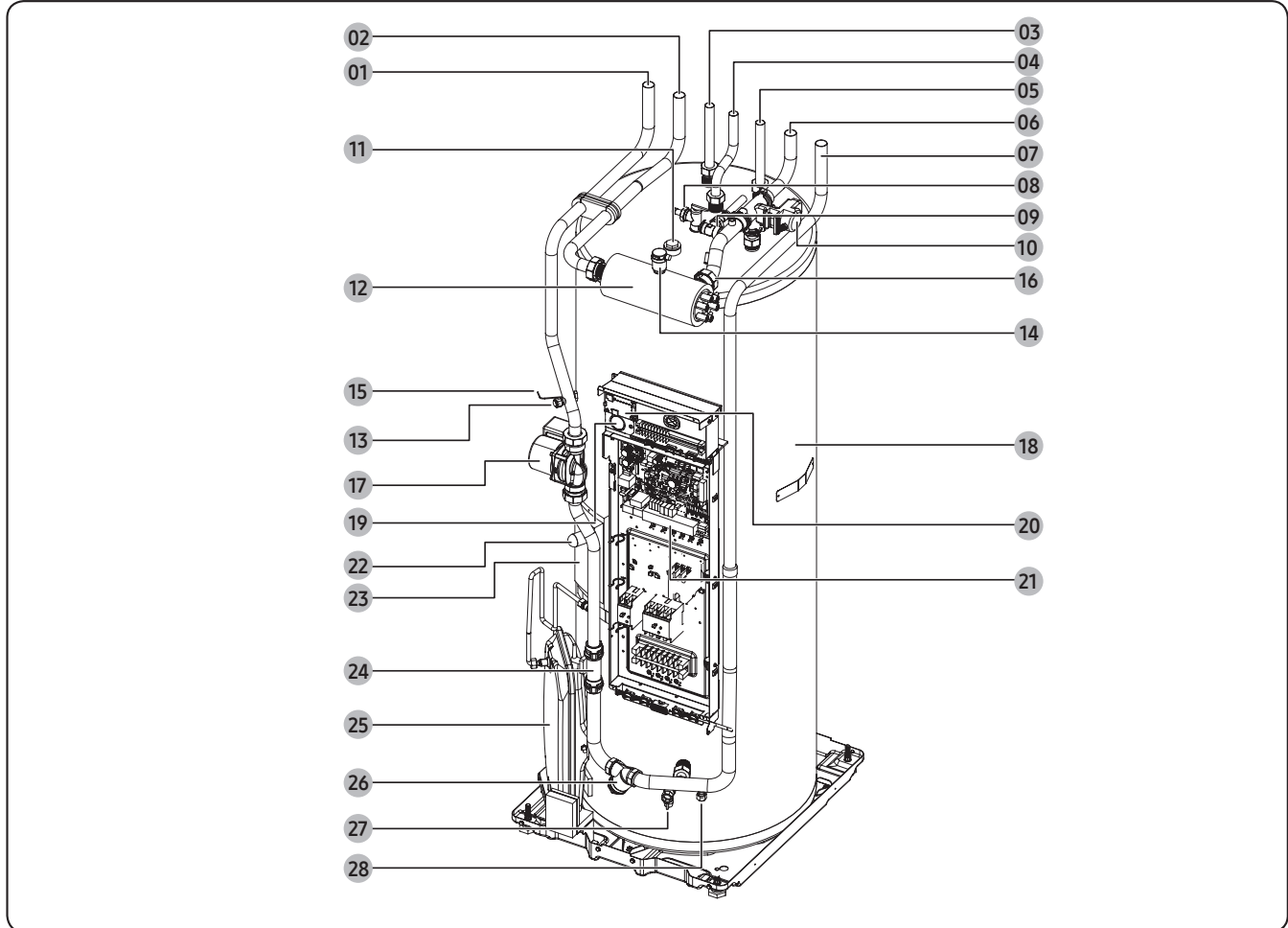

NO	Part name	Note	NO	Part name	Note
01	Water pipe (Return to heat pump)	ø28, Straight pipe	15	Tank thermistor	
02	Water pipe (Flow from heat pump)	ø28, Straight pipe	16	Heater thermistor	
03	Hot water outlet	ø22, Straight pipe	17	Water pump	
04	Secondary return	ø22, Straight pipe (260 L option)	18	Water tank	200 L / 260 L
05	Cold water inlet	ø22, Straight pipe	19	Manometer	0~4 bar
06	Space heating outlet	ø28, Straight pipe	20	S/D converter	
07	Space heating inlet	ø28, Straight pipe	21	Control box	
08	T/P valve	7 bar, 90°C	22	Booster heater	3kW
09	Pressure relief valve	3 bar, BSPP 1/2"	23	Booster heater thermostat	
10	3-way valve		24	Flow sensor	
11	Anode bar	BSPP 1"	25	Expasion vessel	8 L, Pre-charge gas: 0.1 MPa, N2, BSPP 3/8"
12	Back-up heater		26	Strainer	
13	Drain port		27	Tank drain valve	
14	Air vent	BSPP 3/8"	28	Drain port	Primary circuit

3. Tank integrated hydro unit

3-3. Electrical wiring diagram

AE200/260RNWMEG/EU

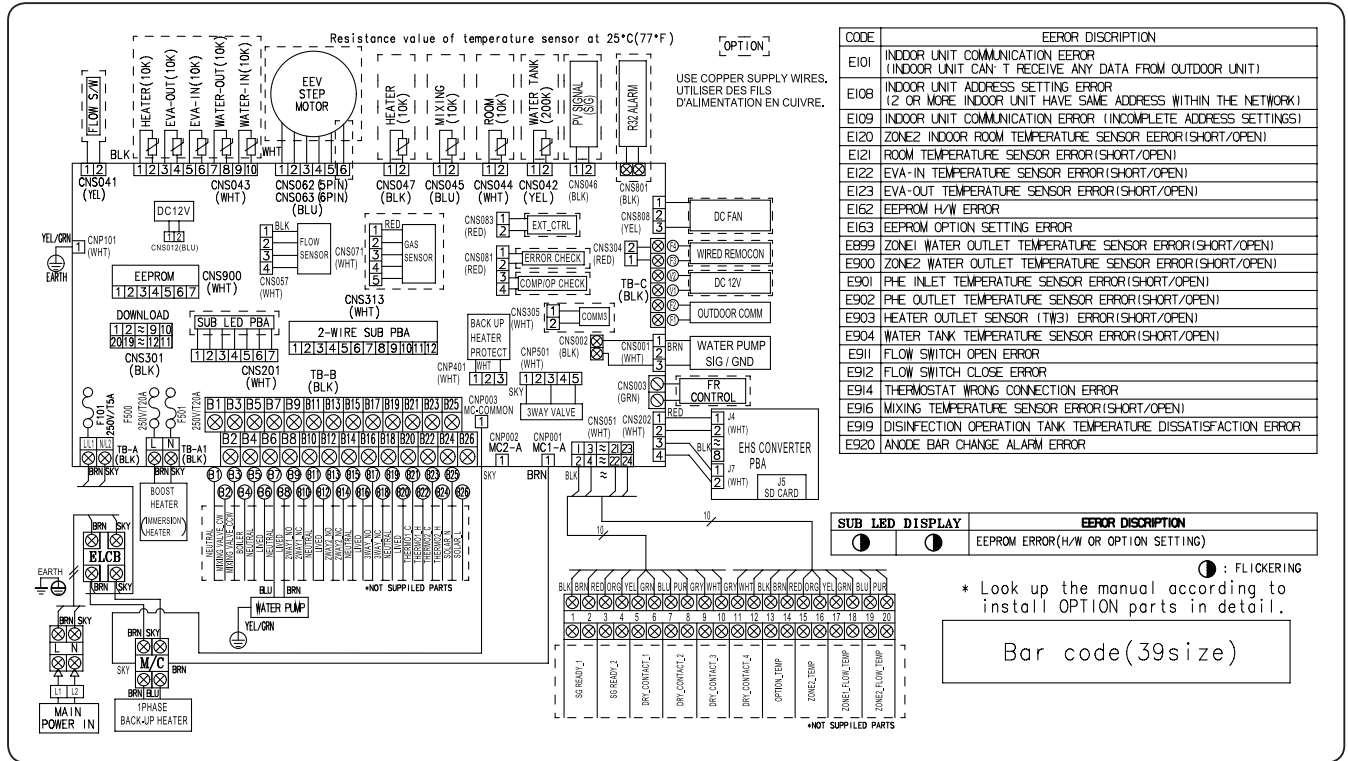

* It does not support external input(CNS083)/output(CNS081) signal function

HEATER	Thermistor HEATER(10K)	EVA-OUT	Thermistor EVA-OUT(10K)
EVA-IN	Thermistor EVA-IN(10K)	WATER-OUT	Thermistor WATER-OUT(10K)
WATER-IN	Thermistor WATER-IN(10K)	WATER TANK	Thermistor WATER TANK(200K)
MIXING	Thermistor MIXING VALVE(10K)	WIRED REMOCON	Wired Remote Controller
OUTDOOR COMM	Outdoor Communication	SIG/GND	Signal/Ground
ELCB	Earth Leakage Circuit Breaker	M/C	Magnetic Contactor

NOTES

1. This wiring diagram applies only to the Indoor unit.
2. Symbols show as follow :
blk: black, red: red, blu: blue, wht: white, yel: yellow, brn: brown, sky: skyblue, grn: green
3. For connection wiring indoor-outdoor transmission F1-F2, indoor-wired remote controller transmission F3-F4.
4. ⚡ Protective earth(SCREW)

3. Tank integrated hydro unit

3-3. Electrical wiring diagram

AE260RNWMGG/EU

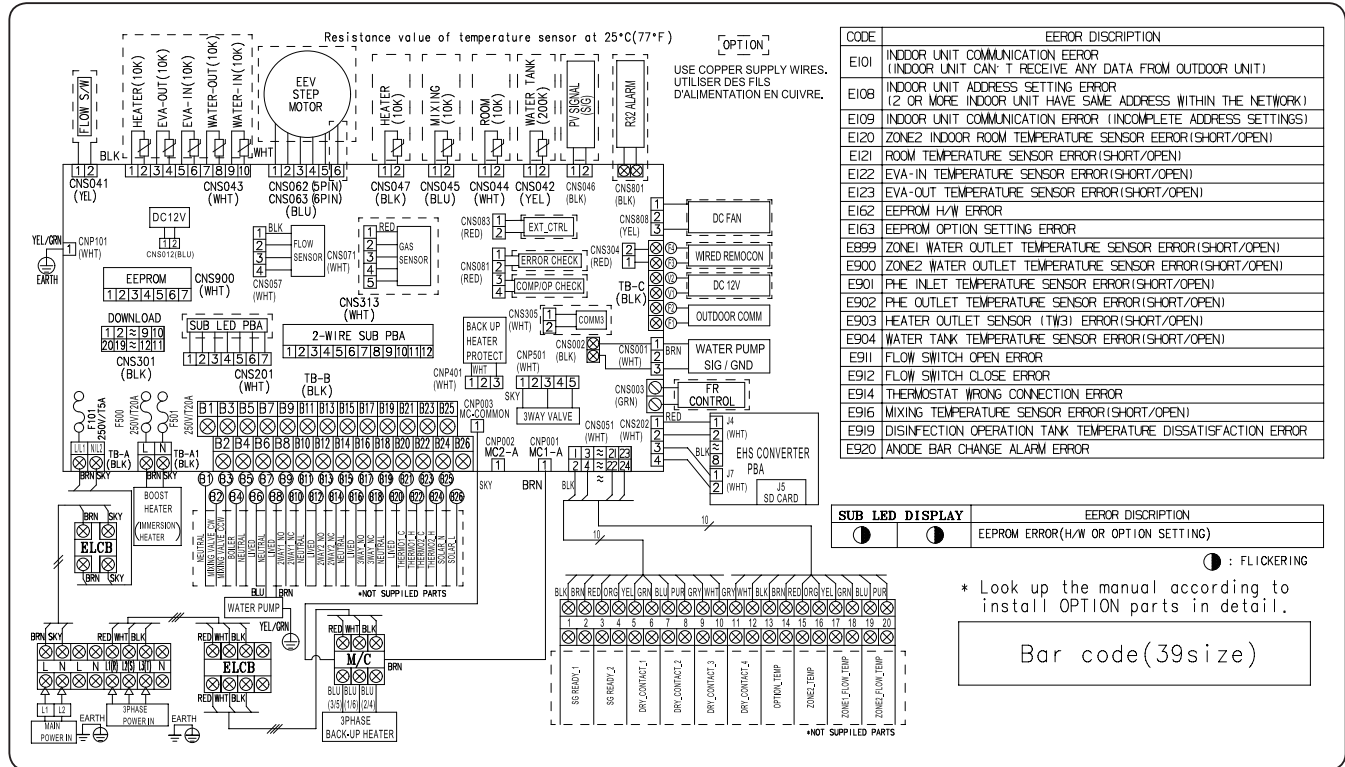

※ It does not support external input(CNS083)/output(CNS081) signal function

HEATER	Thermistor HEATER(10K)	EVA-OUT	Thermistor EVA-OUT(10K)
EVA-IN	Thermistor EVA-IN(10K)	WATER-OUT	Thermistor WATER-OUT(10K)
WATER-IN	Thermistor WATER-IN(10K)	WATER TANK	Thermistor WATER TANK(200K)
MIXING	Thermistor MIXING VALVE(10K)	WIRED REMOCON	Wired Remote Controller
OUTDOOR COMM	Outdoor Communication	SIG/GND	Signal/Ground
ELCB	Earth Leakage Circuit Breaker	M/C	Magnetic Contactor

NOTES

1. This wiring diagram applies only to the Indoor unit.
2. Symbols show as follow :
blk: black, red: red, blu: blue, wht: white, yel: yellow, brn: brown, sky: skyblue, grn: green
3. For connection wiring indoor-outdoor transmission F1-F2, indoor-wired remote controller transmission F3-F4.
4. (⏚) Protective earth(SCREW)

3. Tank integrated hydro unit

3-4. Sound data

Capacity (Liter)	Model	Sound Pressure dB(A) (Heating)	Sound Power dB(A) (Heating)
200	AE200RNWMEG/EU+AE050RXYDEG/EU	26	40
	AE200RNWMEG/EU+AE080RXYDEG/EU	26	40
	AE200RNWMEG/EU+AE120RXYDEG/EU	30	44
	AE200RNWMEG/EU+AE160RXYDEG/EU	30	44
260	AE260RNWMEG/EU+AE080RXYDEG/EU	26	40
	AE260RNWMEG/EU+AE120RXYDEG/EU	30	44
	AE260RNWMEG/EU+AE160RXYDEG/EU	30	44
	AE260RNWMGG/EU+AE080RXYDGG/EU	26	40
	AE260RNWMGG/EU+AE120RXYDGG/EU	30	44
	AE260RNWMGG/EU+AE160RXYDGG/EU	30	44

NOTE

- Specifications may be subject to change without prior notice.
- Sound Pressure Level
 - Sound pressure level is obtained in an anechoic room.
 - Sound pressure level is a relative value, depending on the distance and acoustic environment.
 - Sound pressure level may differ depending on operation condition.
 - dBA = A-weighted sound pressure level
 - Reference acoustic pressure 0 dB = 20μPa
- Sound Power Level
 - Sound power level is an absolute value that a sound source generates.
 - dBA = A-weighted sound power level.
 - Reference power : 1pW.
 - Measured according to ISO 3741.

3. Tank integrated hydro unit

3-4. Sound data

Sound Pressure level

Unit: dB(A)

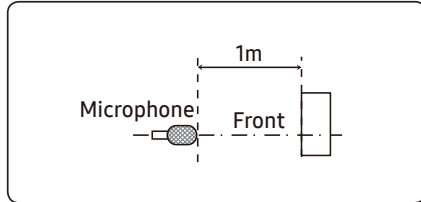

Model	Heating
AE200RNWMEG/EU+AE050RXYDEG/EU	26
AE200RNWMEG/EU+AE080RXYDEG/EU	26
AE200RNWMEG/EU+AE120RXYDEG/EU	30
AE200RNWMEG/EU+AE160RXYDEG/EU	30

- NR Curve

1) AE200RNWMEG/EU+AE050RXYDEG/EU

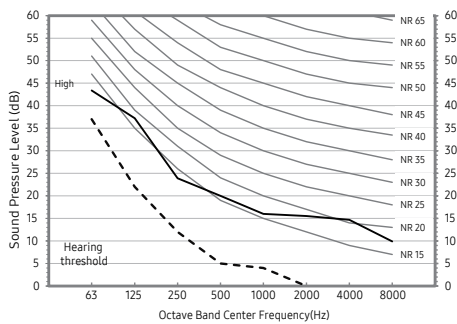

2) AE200RNWMEG/EU+AE080RXYDEG/EU

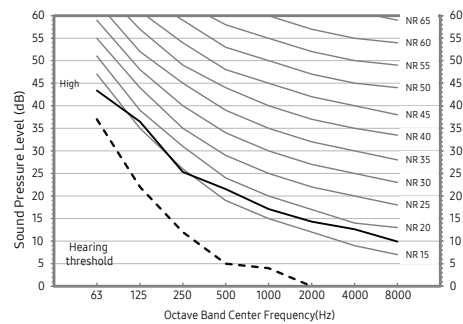

3) AE200RNWMEG/EU+AE120RXYDEG/EU

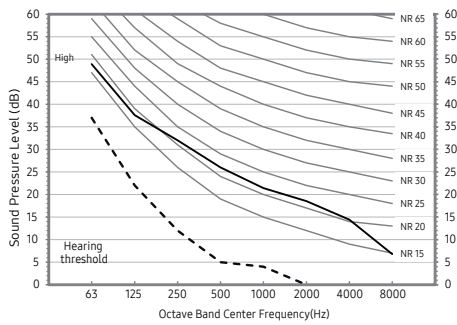

4) AE200RNWMEG/EU+AE160RXYDEG/EU

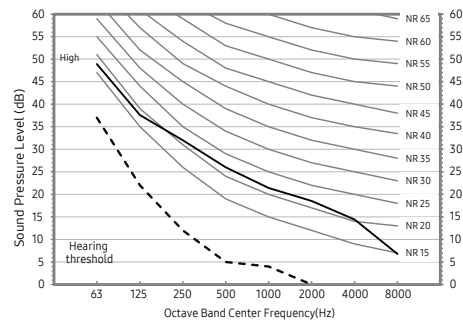

NOTE

- Specifications may be subject to change without prior notice.
- Sound Pressure Level
 - Sound pressure level is obtained in an anechoic room.
 - Sound pressure level is a relative value, depending on the distance and acoustic environment.
 - Sound pressure level may differ depending on operation condition.
 - dBA = A weighted sound pressure level
 - Reference acoustic pressure 0 dB = 20μPa

3. Tank integrated hydro unit

3-4. Sound data

Sound Pressure level

Unit: dB(A)

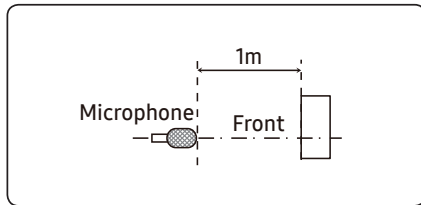

Model	Heating
AE260RNWMEG/EU+AE080RXYDEG/EU	26
AE260RNWMEG/EU+AE120RXYDEG/EU	30
AE260RNWMEG/EU+AE160RXYDEG/EU	30

- NR Curve

1) AE260RNWMEG/EU+AE080RXYDEG/EU

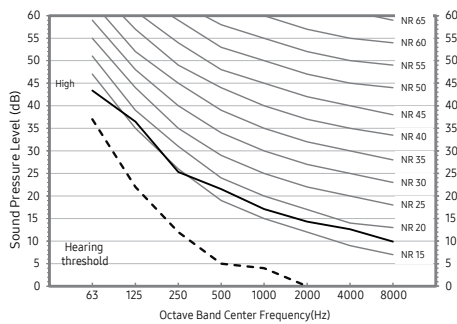

2) AE260RNWMEG/EU+AE120RXYDEG/EU

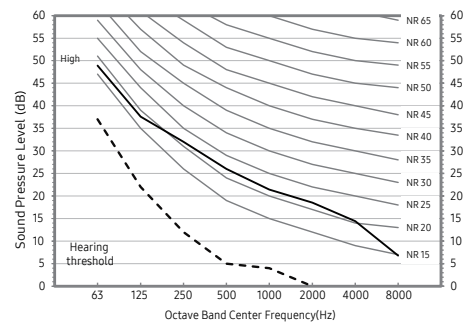

3) AE260RNWMEG/EU+AE160RXYDEG/EU

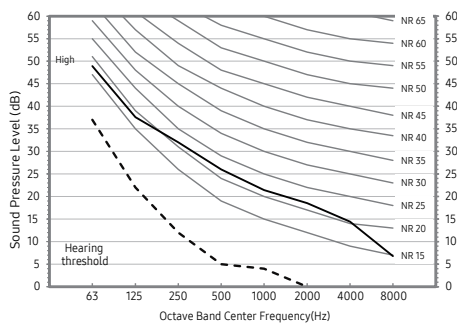

NOTE

- Specifications may be subject to change without prior notice.
- Sound Pressure Level
 - Sound pressure level is obtained in an anechoic room.
 - Sound pressure level is a relative value, depending on the distance and acoustic environment.
 - Sound pressure level may differ depending on operation condition.
 - dBA = A weighted sound pressure level
 - Reference acoustic pressure 0 dB = 20μPa

3. Tank integrated hydro unit

3-4. Sound data

Sound Pressure level

Unit: dB(A)

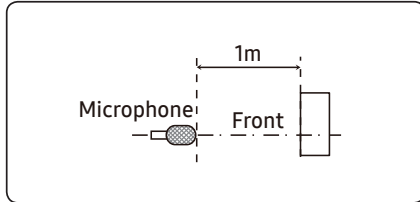

Model	Heating
AE260RNWMGG/EU+AE080RXYDGG/EU	26
AE260RNWMGG/EU+AE120RXYDGG/EU	30
AE260RNWMGG/EU+AE160RXYDGG/EU	30

- NR Curve

1) AE260RNWMGG/EU+AE080RXYDGG/EU

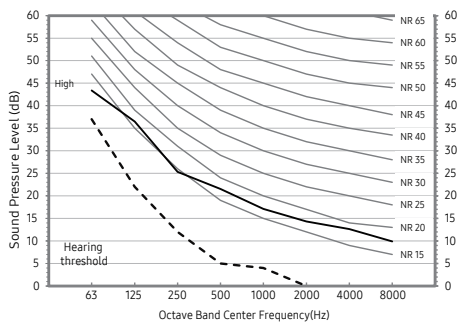

2) AE260RNWMGG/EU+AE120RXYDGG/EU

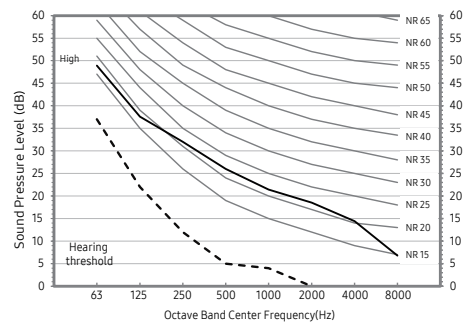

3) AE260RNWMGG/EU+AE160RXYDGG/EU

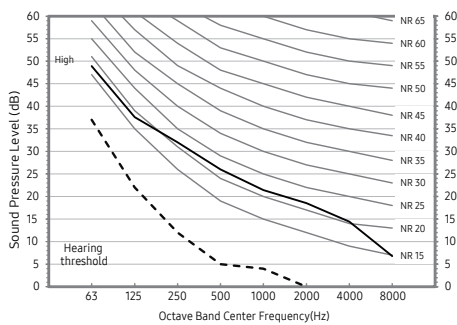

NOTE

- Specifications may be subject to change without prior notice.
- Sound Pressure Level
 - Sound pressure level is obtained in an anechoic room.
 - Sound pressure level is a relative value, depending on the distance and acoustic environment.
 - Sound pressure level may differ depending on operation condition.
 - dBA = A weighted sound pressure level
 - Reference acoustic pressure 0 dB = 20μPa

3. Tank integrated hydro unit

3-4. Sound data

Sound Power level

NOTE

- Specifications may be subject to change without prior notice
 - Sound power level is an absolute value that a sound source generates.
 - dBA = A-weighted sound power level.
 - Reference power : 1pW.
 - Measured according to ISO 3741.

Model	Power (dBA)
AE200RNWMEG/EU+AE050RXYDEG/EU	40
AE200RNWMEG/EU+AE080RXYDEG/EU	40
AE200RNWMEG/EU+AE120RXYDEG/EU	44
AE200RNWMEG/EU+AE160RXYDEG/EU	44

1) AE200RNWMEG/EU+AE050RXYDEG/EU

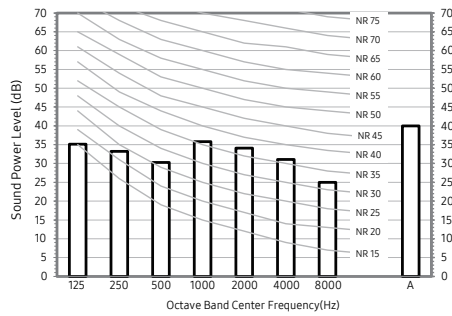

2) AE200RNWMEG/EU+AE080RXYDEG/EU

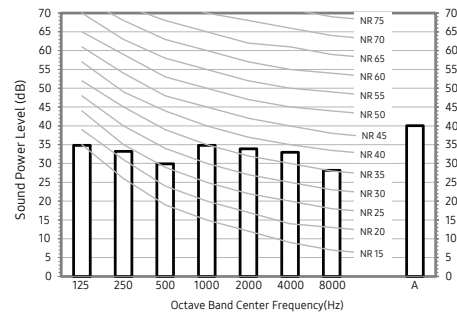

3) AE200RNWMEG/EU+AE120RXYDEG/EU

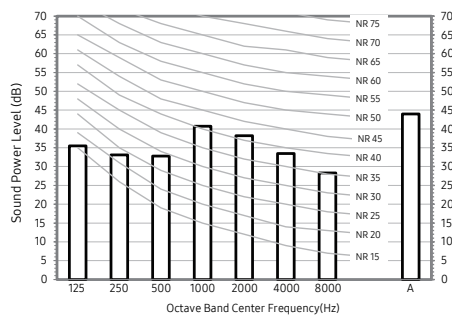

4) AE200RNWMEG/EU+AE160RXYDEG/EU

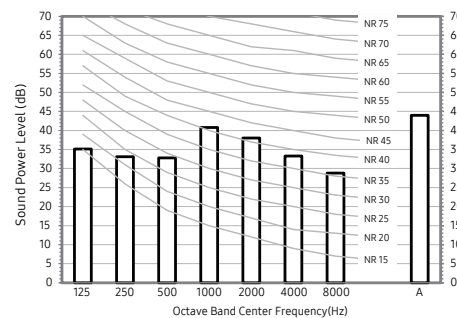

3. Tank integrated hydro unit

3-4. Sound data

Sound Power level

NOTE

- Specifications may be subject to change without prior notice
 - Sound power level is an absolute value that a sound source generates.
 - dBA = A-weighted sound power level.
 - Reference power : 1pW.
 - Measured according to ISO 3741.

Model	Power (dBA)
AE260RNWMEG/EU+ AE080RXYDEG/EU	40
AE260RNWMEG/EU+ AE120RXYDEG/EU	44
AE260RNWMEG/EU+ AE160RXYDEG/EU	44

1) AE260RNWMEG/EU+AE080RXYDEG/EU

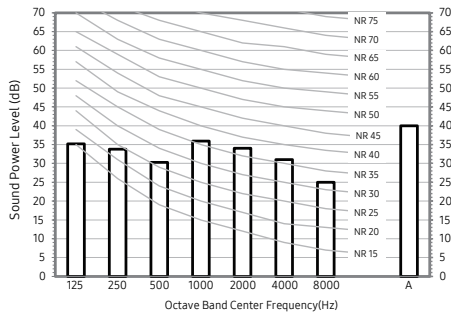

2) AE260RNWMEG/EU+AE120RXYDEG/EU

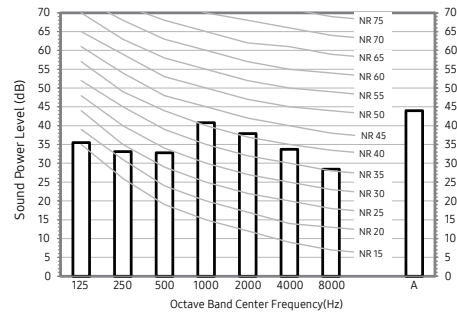

3) AE260RNWMEG/EU+AE160RXYDEG/EU

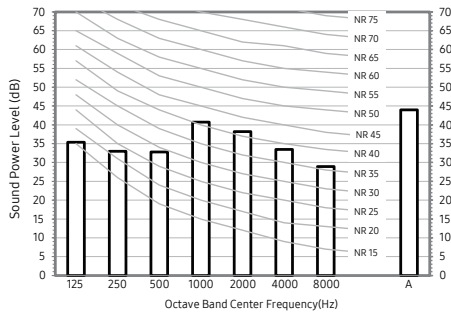

3. Tank integrated hydro unit

3-4. Sound data

Sound Power level

NOTE

- Specifications may be subject to change without prior notice
 - Sound power level is an absolute value that a sound source generates.
 - dBA = A-weighted sound power level.
 - Reference power : 1pW.
 - Measured according to ISO 3741.

Model	Power (dBA)
AE260RNWMGG/EU+AE080RXYDGG/EU	40
AE260RNWMGG/EU+AE120RXYDGG/EU	44
AE260RNWMGG/EU+AE160RXYDGG/EU	44

1) AE260RNWMGG/EU+AE080RXYDGG/EU

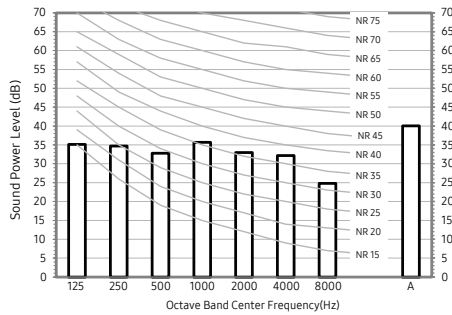

2) AE260RNWMGG/EU+AE120RXYDGG/EU

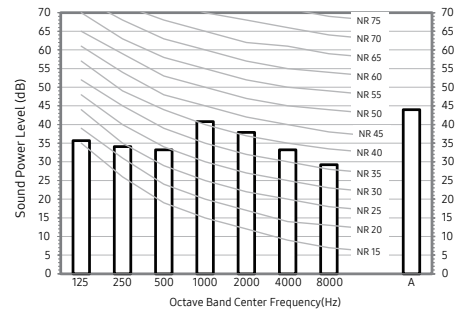

3) AE260RNWMGG/EU+AE160RXYDGG/EU

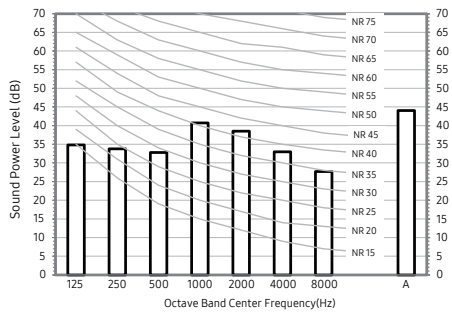

3. Tank integrated hydro unit

3-5. Piping diagram

AE200/260RNWS*G/EU

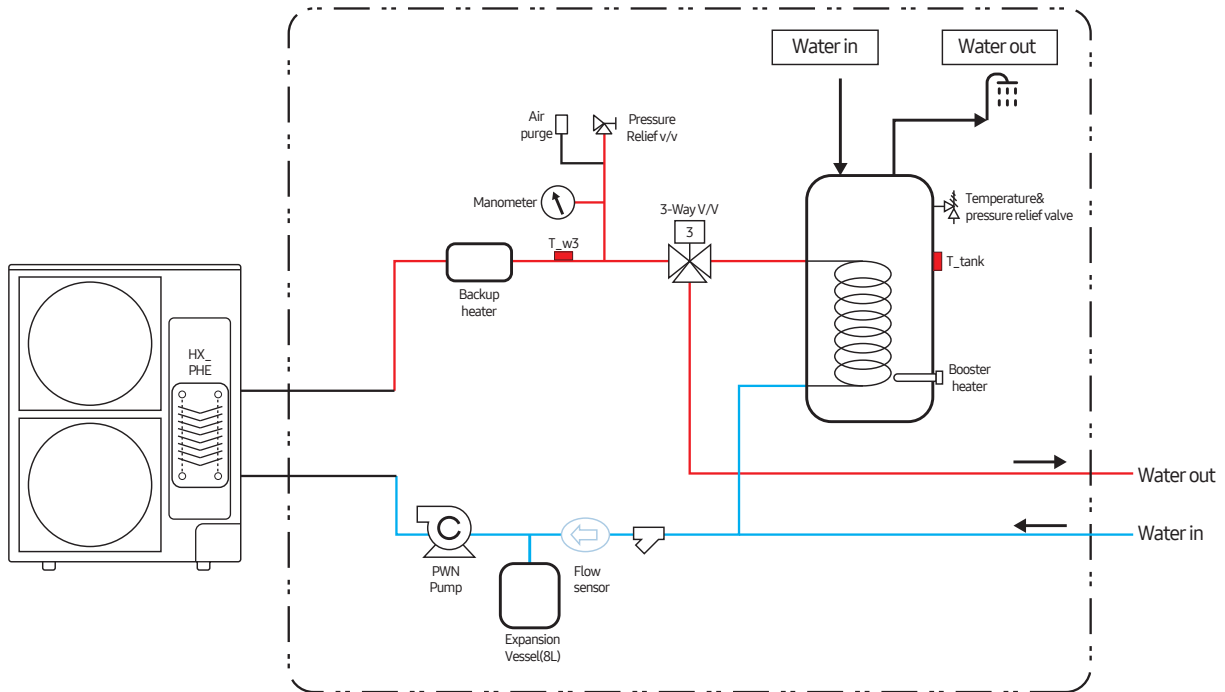

4. Installation

Tank integrated hydro unit

Mono outdoor + Tank Integrated Hydro Unit

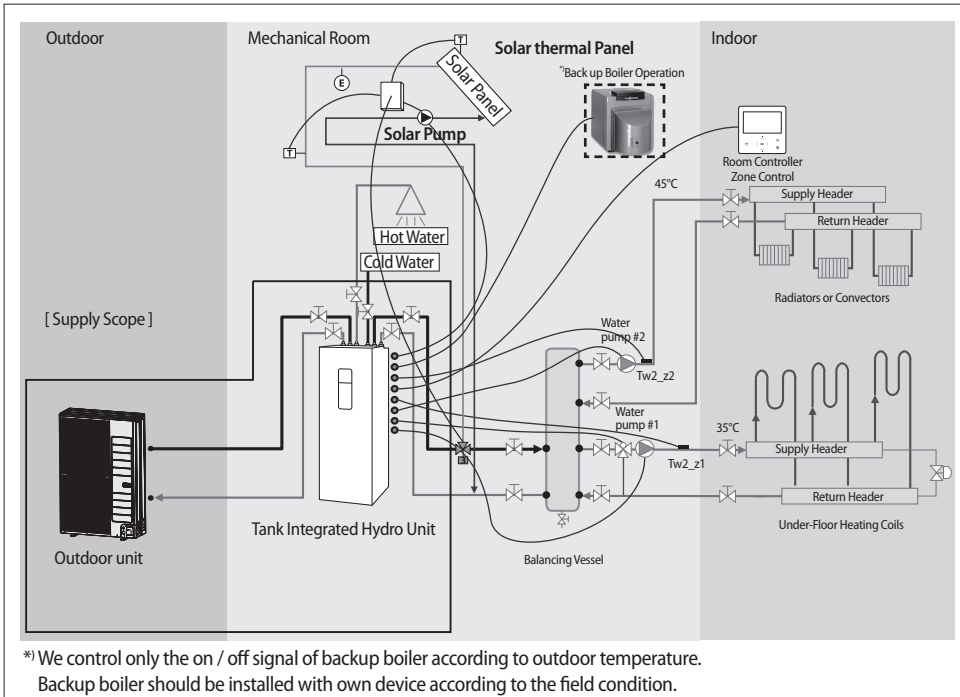

※ In case you want more information about the controllers and accessories, please refer to the Controller and Accessory TDB on pvi.Samsung.com site or Global Partner Portal site.

4. Installation

Tank integrated hydro unit

Installation of mixing valve

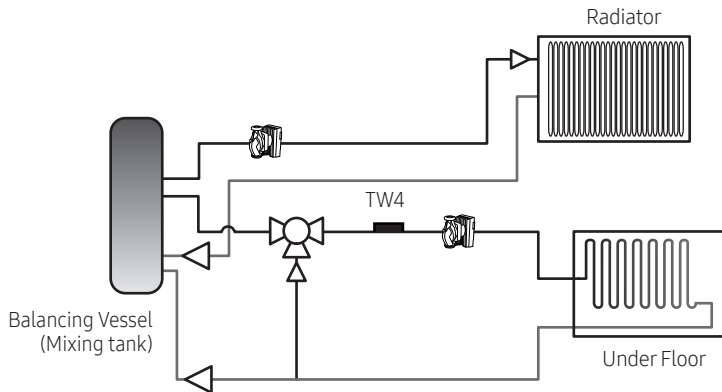

When two different zones are used with different temperature, adjust the temperature of discharge water to high temperature water and control the amount of bypass to provide low temperature water by applying the mixing valve and temperature sensor of the mixing valve (TW4).

1. Select a mixing valve from the manufacturers as below (recommended) and install it at the entrance of the zone.
2. Install the supplied temperature sensor (TW4) on the rear part of the mixing valve. Install TW4 Sensor within 1m of Mixing Valve.
3. Since running time varies depending on the manufacturer, set the FSV (default 90 sec.) by referring to the FSV value below.

Maker		BELIMO	SIEMENS	HONEYWELL
Model code	3 Way Valve	R3020-6P3-S2	VXP45.20-4 (kvs 4)	V5011E1213
	Actuator	LR230A(-S)	SSB31	ML6420A3015
Running time		90 sec.	150 sec.	60 sec.
FSV(#4046) setting		9	15	6

※ The table above is for your reference. It can be changed without advanced notice.

※ In case you want more information about the controllers and accessories, please refer to the Controller and Accessory TDB on pvi.Samsung.com site or Global Partner Portal site.

4. Installation

Tank integrated hydro unit

4. Set the FSV value by referring to the table below depending on installation environment.

Function	Details	Code	Unit	Default	Min.	Max.
Mixing valve	Use or not	4041	-	0(No)	0	2
	Target temperature difference (Heating) (TW3-TW4)	4042	°C	10	5	15
	Target temperature difference (Cooling) (TW4-TW3)	4043	°C	10	5	15
	Control factor	4044	-	2	1	5
	Interval of valve control	4045	Min.	2	1	30
	Running time (10 second unit)	4046	(x10) sec	9	6	24

※ 4041 =1 : Controlled based on the temperature difference (4042, 4043)

※ 4041 =2 : Controlled based on the temperature difference of the WL value

ex) Heating

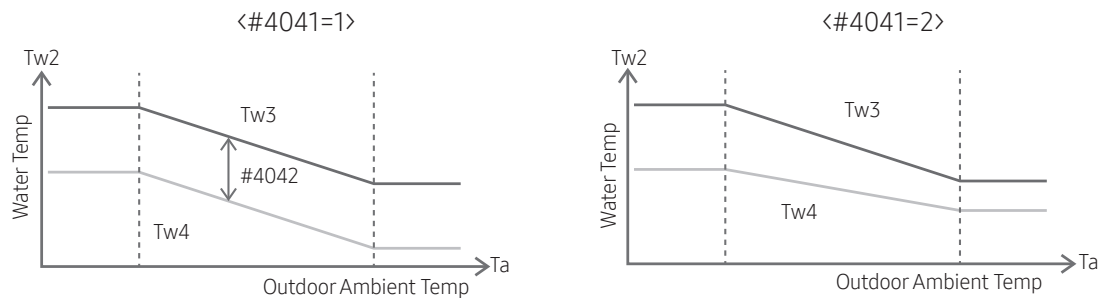

※ The mixing valve is controlled based on the FCU WL value.

※ As the #4044 value increases and the #4045 value decreases, the control speed increases. (Temperature hunting may occur if the control speed increases depending on the load.)

※ The additional pump and mixing valve should be purchased separately. TW4 sensor is included in the product accessories.

※ TW3 : Water temp. sensor 3

CAUTION

- When the thermostat control is set as 'Use', the mixing valve can be used for Zone 1 and Zone 2. (When both FSV #2091 and #2092 are set as 1/2)
- When using Zone control (FSV 4061 = 1), ignore Thermostat signal.

※ In case you want more information about the controllers and accessories, please refer to the Controller and Accessory TDB on pvi.Samsung.com site or Global Partner Portal site.

4. Installation

Tank integrated hydro unit

2-zone control using Thermostat

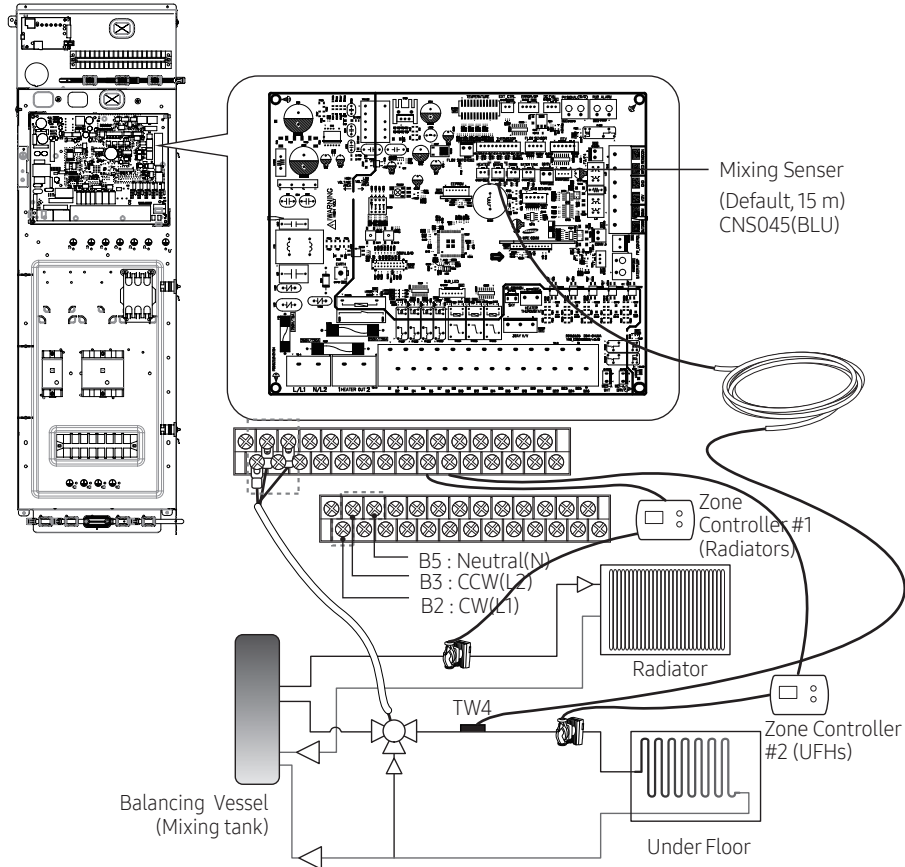

Description	No. of wires	Max. current	Thickness	Supply Scope
Mixing valve	4	22 mA	> 0.75 mm ² , H05RN-F or H07RH-F	Field supply (230 V~, Input)

1. Before the installation, hydro unit should be turned off.
2. Using the appropriate equipment to correct position of terminal block as shown on the diagram.

※ In case you want more information about the controllers and accessories, please refer to the Controller and Accessory TDB on pvi.Samsung.com site or Global Partner Portal site.

4. Installation

Tank integrated hydro unit

2-Zone Control Using Remote Controller

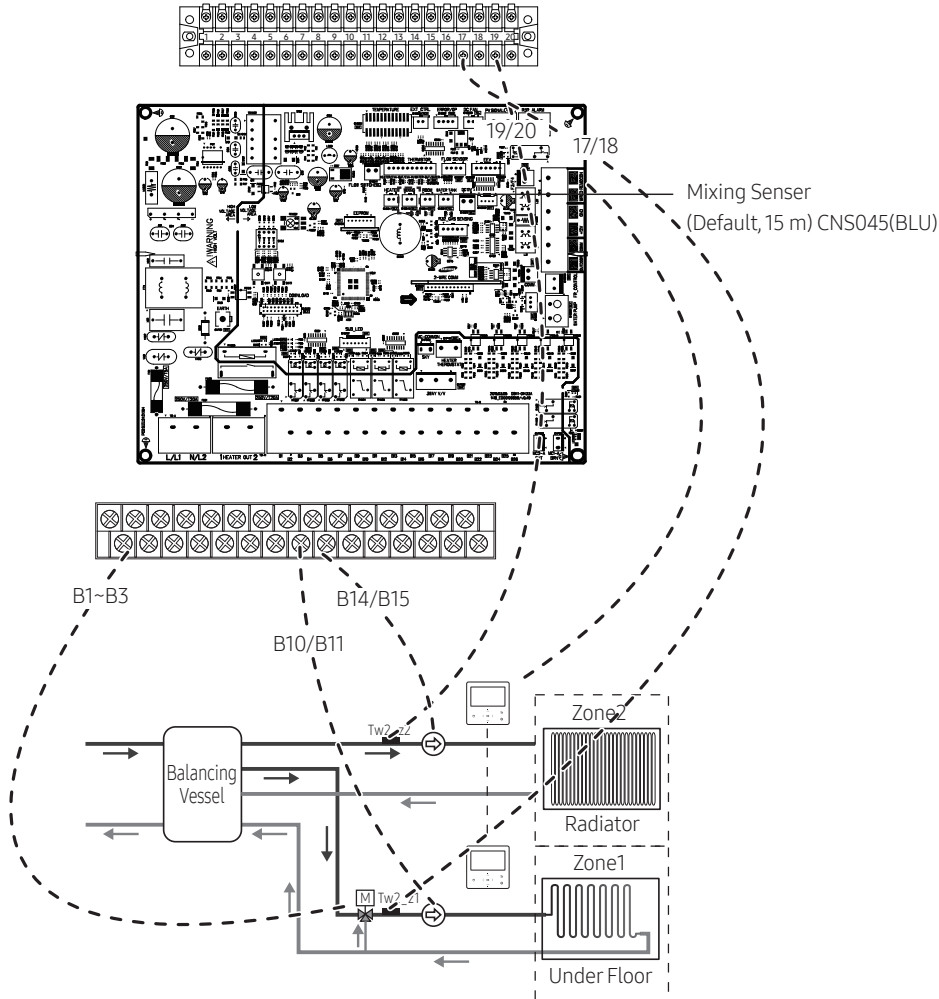

You can operate the 2-zone control using a mixing value, water-out temperature sensors, and built-in or external room temperature sensors installed in a wired remote controller.

When both zones are simultaneously Thermo on, the operation is performed based on Zone2. Therefore, set the zone that you want to have the higher set temperature to Zone2.

(The mixing valve must be installed in the zone that you want to have the lower set temperature.)

1. Install the mixing valve. (See "Installation of mixing valve.")
 2. Install the water-out temperature sensors (Tw2_z1, Tw2_z2) for all zones.
 3. Unlike the zone control with a thermostat, connect the water pump signal lines to the product.
 - Zone1 water pump connection: B10 (L1) + B11 (N)
 - Zone2 water pump connection: B14 (L1) + B15 (N)
 4. FSV 4061 = 1: Enable the 2-zone control using the wired remote controller.
- ※ If you want to operate the 2-zone control by using water-out temperatures, you have only to complete steps 1 to 4 above.
- ※ If you want to operate the 2-zone control by using room temperatures and built-in temperature sensors in wired remote controllers, you must install two wired remote controllers in each room. (If you use external room temperature sensors, you can control each room temperature with only one wired remote controller.)
- ※ In case you want more information about the controllers and accessories, please refer to the Controller and Accessory TDB on pvi.Samsung.com site or Global Partner Portal site.

4. Installation

Tank integrated hydro unit

Wiring work

* When you use inlet hole through the cabinet top positions for power/communication wires, please fix the wire by using mount tie of the cabinet right.

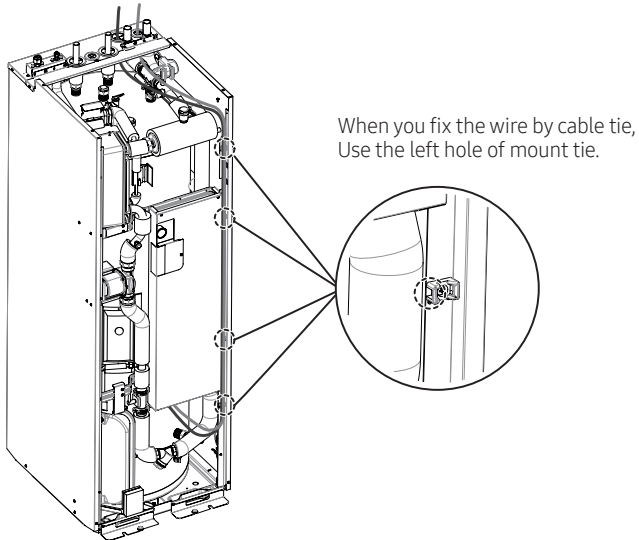

2 wires for communication cable

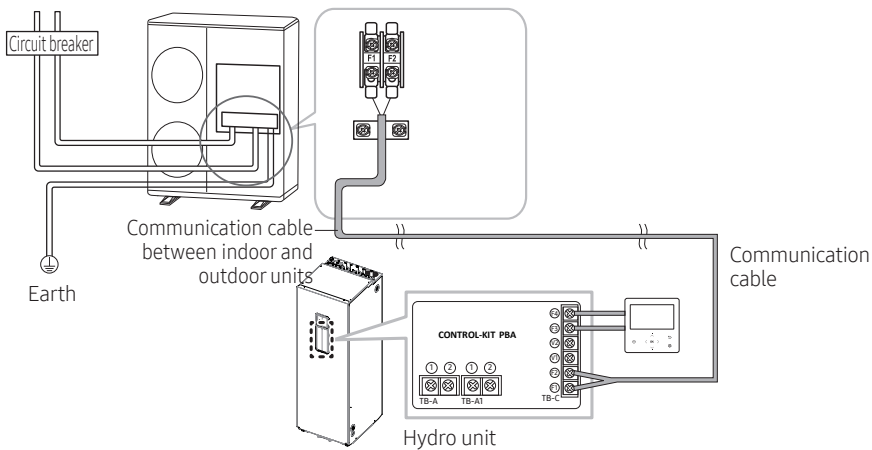

Communication cable connection

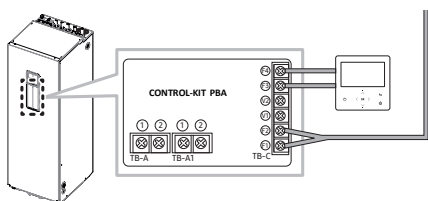

※ In case you want more information about the controllers and accessories, please refer to the Controller and Accessory TDB on pvi.Samsung.com site or Global Partner Portal site.

4. Installation

Tank integrated hydro unit

1. 1 phase product

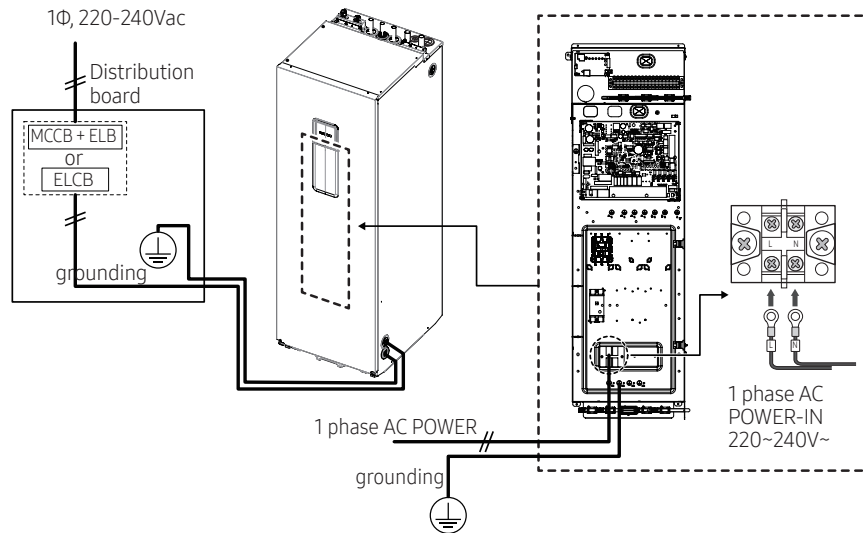

2. 3 phase product

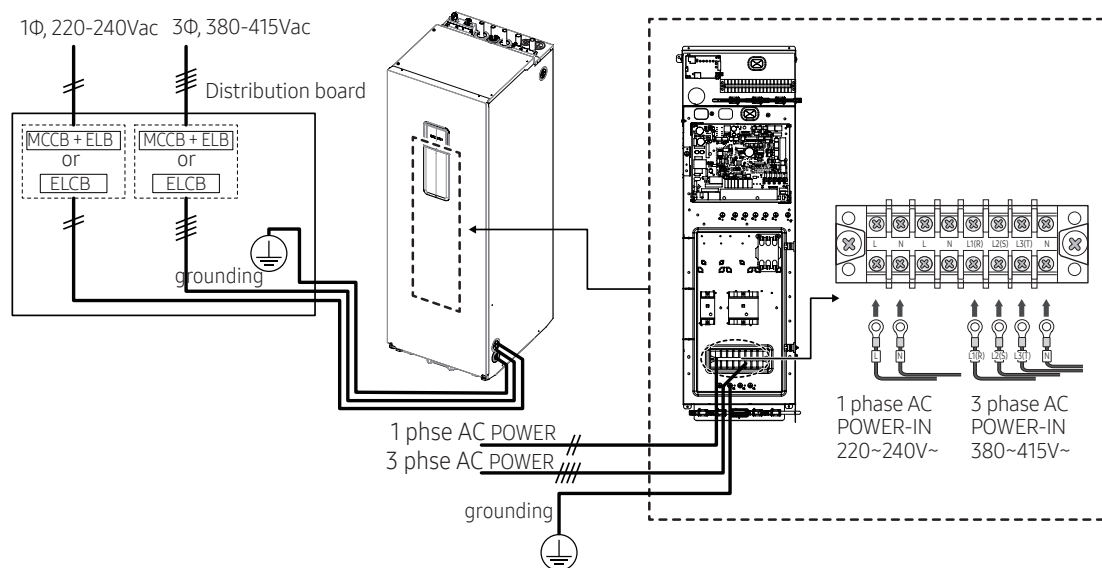

CAUTION

- If the supply cable is damaged, it must be replaced by a special cable or assembly available from the manufacturer or installer.
 - Circuit Breaker (ELCB, ELB, MCCB etc.) for outdoor and indoor units shall be installed by installers because they are not sub-parts in the units. But you don't need to install for hydro unit (Built-in ELCB).
 - It cause damage to chassis, PCB parts if the main power is not connected correctly. You should make certain that R, S, T is connected correctly before turning on the main power. (3 phase models only)
- ※ ELCB : Earth leakage circuit breaker
 ELB : Earth leakage breaker
 MCCB : Molded case circuit breaker

- ※ In case you want more information about the controllers and accessories, please refer to the Controller and Accessory TDB on pvi.Samsung.com site or Global Partner Portal site.

4. Installation

Outdoor Unit

Space requirements for outdoor unit

When installing 1 outdoor unit

(Unit : mm)

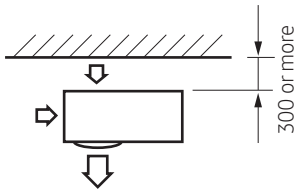

※ When the air outlet is opposite the wall

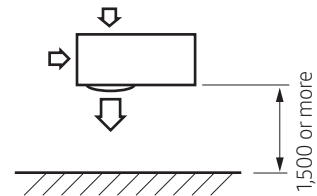

※ When the air outlet is towards the wall

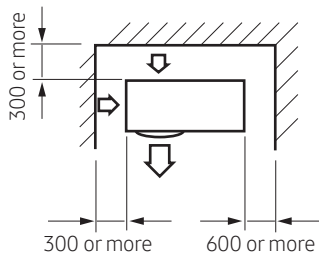

※ When 3 sides of the outdoor unit are blocked by the wall

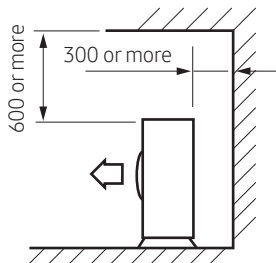
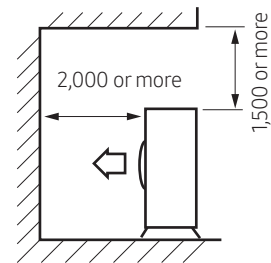

※ The upper part of the outdoor unit and the air outlet is opposite the wall

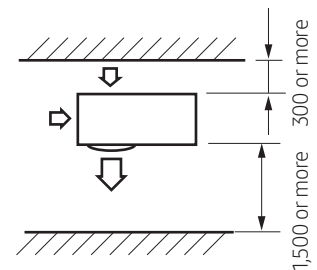

※ When front and rear side of the outdoor unit is towards the wall

※ In case you want more information about the controllers and accessories, please refer to the Controller and Accessory TDB on pvi.Samsung.com site or Global Partner Portal site.

4. Installation

Outdoor Unit

When installing more than 1 outdoor unit

(Unit : mm)

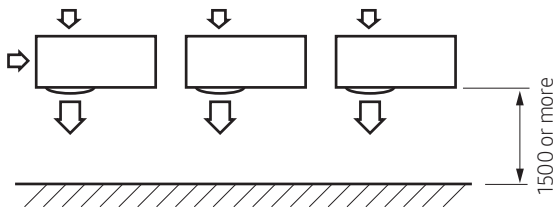

※ When the air outlet is towards the wall

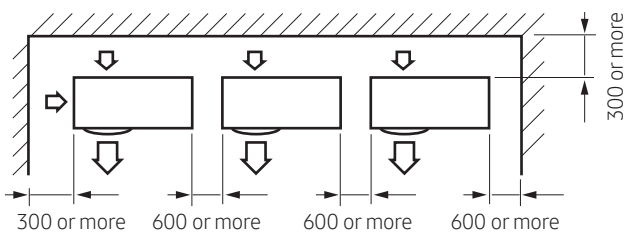

※ When 3 sides of the outdoor unit are blocked by the wall

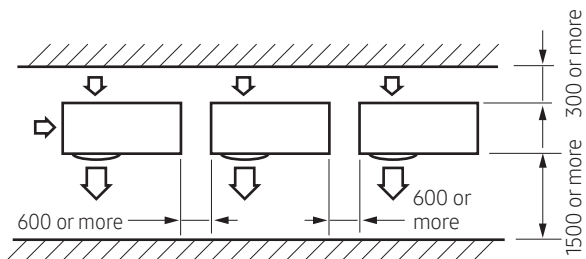

※ When front and rear side of the outdoor unit is towards the wall

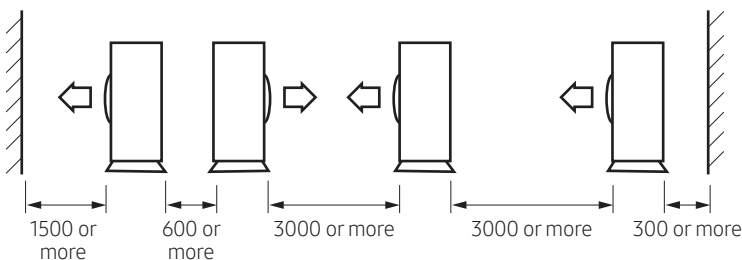

※ When front and rear side of the outdoor unit is towards the wall

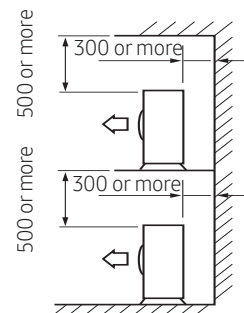

※ The upper part of the outdoor unit and the air outlet is opposite the wall

⚠ CAUTION

- The units must be installed according to distances declared, in order to permit accessibility from each side, either to guarantee correct operation of maintenance or repairing products. The unit's parts must be reachable and removable completely under safety condition (for people or things).

※ In case you want more information about the controllers and accessories, please refer to the Controller and Accessory TDB on pvi.Samsung.com site or Global Partner Portal site.

4. Installation

Outdoor Unit

Outdoor unit installation

The outdoor unit must be installed on a rigid and stable base to avoid any increase in the noise level and vibration, particularly if the outdoor unit is to be installed in a location exposed to strong winds or at a height, the unit must be fixed to an appropriate support (wall or ground).

- Fix the outdoor unit with anchor bolts.

NOTE

- The anchor bolt must be 20mm or higher from the base surface.

CAUTION

- When tightening the anchor bolt, tighten the rubber washer to prevent the outdoor unit bolt connection part from corroding.
- Make a drain outlet around the base for outdoor unit drainage.
- If the outdoor unit is installed on the roof, you have to check the ceiling strength and waterproof the unit.

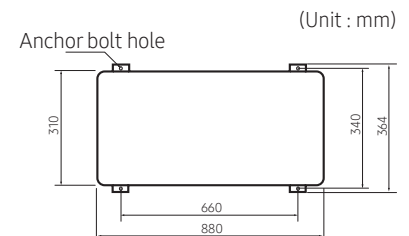
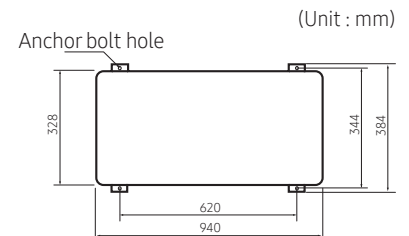

Wiring

Two electronic cables must be connected to the outdoor unit.

- The connection cord between indoor unit and outdoor unit.
- The power cable between outdoor unit and auxiliary circuit breaker.
- Specially for Russian and European market, before installation, the supply authority should be consulted to determine the supply system impedance to ensure compliance.

CAUTION

- During the unit installation make first refrigerant connections and then electrical connections. If unit is uninstalled first disconnect electrical cables, then refrigerant connections.
- Connect the Air to water heat pump to grounding system before performing the electrical connection.
- When installing the unit, you shouldn't use inter connection wire.

※ In case you want more information about the controllers and accessories, please refer to the Controller and Accessory TDB on pvi.Samsung.com site or Global Partner Portal site.

4. Installation

Outdoor Unit

Wiring diagram of power cable

When using ELB for 1 phase and 3 phase

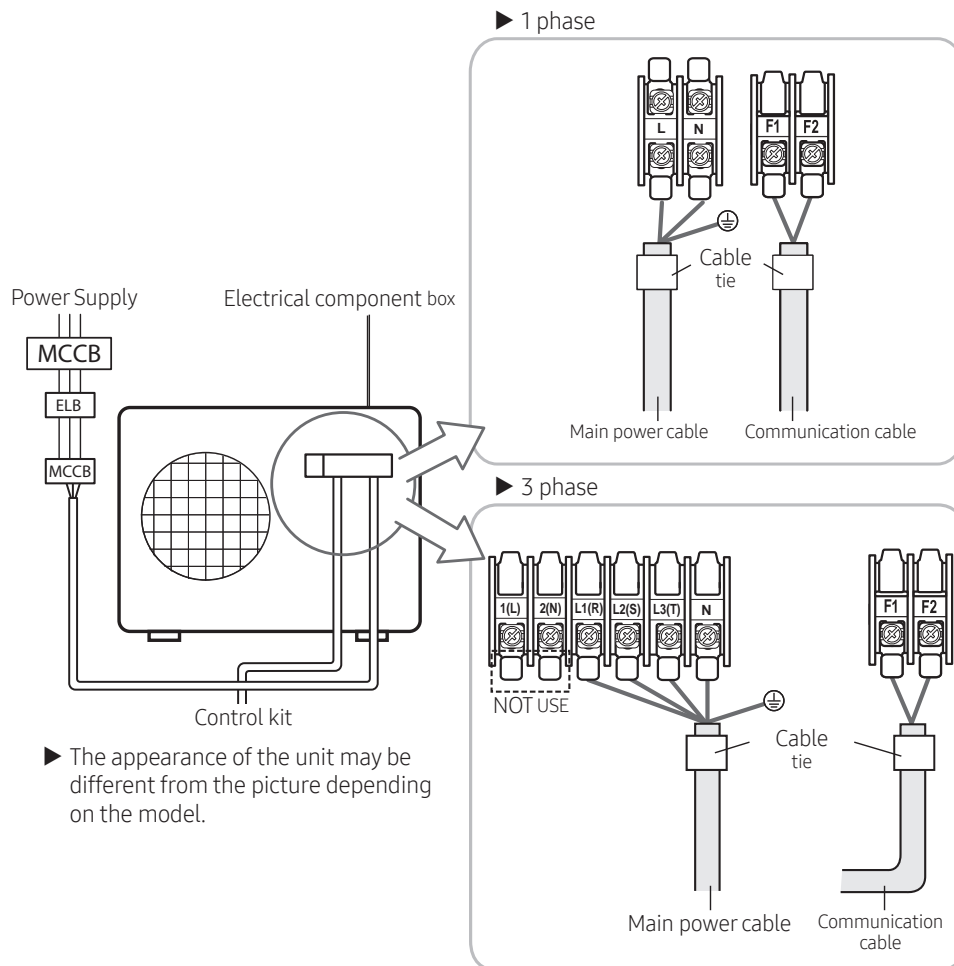

⚠ CAUTION

- You should connect the power cable into the power cable terminal and fasten it with a clamp.
- The unbalanced power must be maintained within 2% of supply rating.
 - If the power is unbalanced greatly, it may shorten the life of the condenser. If the unbalanced power is exceeded over 4% of supply rating, the control kit is protected, stopped and the error mode indicates.
- To protect the product from water and possible shock, you should keep the power cable and the connection cord of the control kit and outdoor units within ducts. (with appropriate IP rating and material selection for your application)
- Ensure that main supply connection is made through a switch that disconnects all poles, with contact gap of a least 3 mm.
- Devices disconnected from the power supply should be completely disconnected in the condition of overvoltage category.
- Keep distances of 50mm or more between power cable and communication cable.

※ In case you want more information about the controllers and accessories, please refer to the Controller and Accessory TDB on pvi.Samsung.com site or Global Partner Portal site.

4. Installation

Outdoor Unit

Wiring diagram of connection cord

1 phase

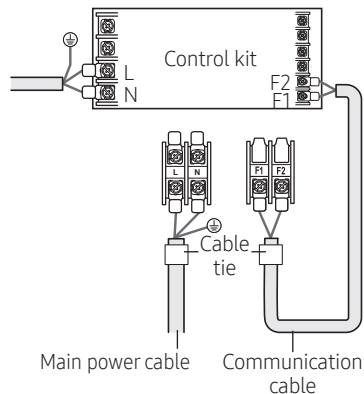

3 phase

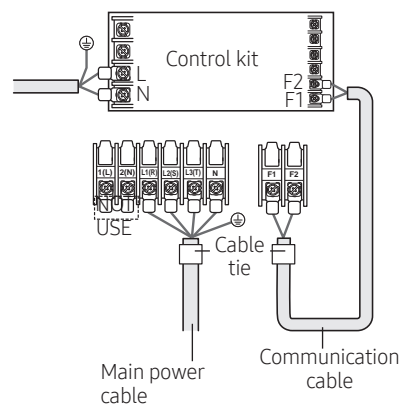

NOTE

- Lay the electrical wiring so that the front cover does not rise up when doing wiring work and attach the front cover securely.
- Ground wire for the indoor unit and outdoor unit connection cable must be clamped to a soft copper tin-plated eyelet terminal with screw hole (NOT SUPPLIED WITH UNIT ACCESSORIES).



Primary water circuit freeze protection

If the ambient temperature is below freezing conditions, freezing of water in the primary circuit (outdoor unit and pipework) may occur during power failure or temporary loss of power by SmartGrid activation. To prevent damaging of the product (outdoor unit and pipework) due to freezing, we advise to add antifreeze according to below stated table.

Freeze protection solutions must use propylene glycol with a toxicity rating of Class 1 as listed in Clinical Toxicology of Commercial Products, 5th Edition.

WARNING • Ethylene glycol is toxic and must not be used in the primary water circuit in case of any cross-contamination of the potable circuit.

Freezing Points of Propylene Glycol - Water Mixtures		
Percent Propylene Glycol [wt. %]	Freezing Point [°F]	Freezing Point [°C]
0	32	0
10	26	-3
20	20	-7
30	10	-12
36	0	-18
40	-5	-20
43	-10	-23
48	-20	-29

※ In case you want more information about the controllers and accessories, please refer to the Controller and Accessory TDB on pvi.Samsung.com site or Global Partner Portal site.

2021. 11
Ver.2.1

Samsung Electronics Co., LTD.

Head Office (Suwon Korea) 129, Samsung-Ro, Yeongtong-Gu, Suwon City, Gyeonggi-Do, Korea 16677
Website : www.samsung.com, <https://partnerhub.samsung.com> Email : airconditioner@samsung.com
Images and data in this book may subject to change without prior notice.