

Air to Water Heat Pump

Installation manual

Hydro Unit AE090RNYD**

- Thank you for purchasing this Samsung Product.
- Before operating this unit, please read this installation manual carefully and retain it for future reference.



DB68-08552A-04

SAMSUNG

Contents

PREPARATION

Safety precautions	3
Product specifications	8
Typical application examples	11
Main components	13
Functional diagram	14
Dimensional drawing	15

INSTALLATION

Installing the unit	16
Pipe work	18
Wiring work	25
Self-test mode of wired remote controller	46

OTHERS

Troubleshooting	47
DHW tank	50
Mixing Valve	56
Temperature sensor work	59
Concrete curing function	62
Installation option setting	64
Optional : Extending the power cable	66
Reference (KEYMARK Certification)	68



Correct Disposal of This Product (Waste Electrical & Electronic Equipment)

(Applicable in countries with separate collection systems)

This marking on the product, accessories or literature indicates that the product and its electronic accessories (e.g. charger, headset, USB cable) should not be disposed of with other household waste at the end of their working life. To prevent possible harm to the environment or human health from uncontrolled waste disposal, please separate these items from other types of waste and recycle them responsibly to promote the sustainable reuse of material resources.

Household users should contact either the retailer where they purchased this product, or their local government office, for details of where and how they can take these items for environmentally safe recycling.

Business users should contact their supplier and check the terms and conditions of the purchase contract. This product and its electronic accessories should not be mixed with other commercial wastes for disposal.

For information on Samsung's environmental commitments and product-specific regulatory obligations, e.g. REACH, visit: www.samsung.com/uk/aboutsamsung/sustainability/environment/our-commitment/data/

Safety precautions

All materials supplied to this manual are indispensable for the safety of equipment.

Users shall establish appropriate safety and health practices and determine the applicability of regulatory limitation based on following descriptions prior to use.



WARNING

- Always disconnect the air to water heat pump from the power supply before servicing it or accessing its internal components.
- Verify that installation and testing operations are performed by qualified personnel.
- Verify that the air to water heat pump is not installed in an easily accessible area.

GENERAL INFORMATION

- ▶ Carefully read the content of this manual before installing the air to water heat pump and store the manual in a safe place in order to be able to use it as reference after installation.
- ▶ For maximum safety, installers shall always carefully read the following warnings.
- ▶ Store the user and installation manual in a safe location and remember to hand it over to the new owner if the air to water heat pump is sold or transferred.
- ▶ This manual explains how to install an indoor unit with a split system with two SAMSUNG units. The use of other types of units with different control systems may damage the units and invalidate the warranty. The manufacturer shall not be responsible for damages arising from the use of non compliant units.
- ▶ The manufacturer shall not be responsible for damage originating from unauthorized changes or the improper connection of electric and hydraulic lines. Failure to comply with these instructions or to comply with the requirements set forth in the "Operating limits" table, included in the manual, shall immediately invalidate the warranty.
- ▶ Do not use the units if damaged. If problems occur, switch the unit off and disconnect it from the power supply.
- ▶ In order to prevent electric shocks, fires or injuries, always stop the unit, disable the protection switch and contact SAMSUNG's technical support if the unit produces smoke, if the power cable is hot or damaged or if the unit is very noisy.
- ▶ Always remember to inspect the unit, electric connections, refrigerant tubes and protections regularly. These operations should be performed by qualified personnel only.
- ▶ The unit contains moving parts, which should always be kept out of the reach of children.
- ▶ Do not attempt to repair, move, alter or reinstall the unit. If performed by unauthorized personnel, these operations may cause electric shocks or fires.
- ▶ Do not place containers with liquids or other objects on the unit.
- ▶ All the materials used for the manufacture and packaging of the air to water heat pump are recyclable.
- ▶ The packing material and exhaust batteries of the remote control(optional) must be disposed of in accordance with current laws.
- ▶ The air to water heat pump contains a refrigerant must be disposed in authorized center or returned to retailer as special wastes.
- ▶ Do not disassemble and alter the heater at your own discretion.
- ▶ Wear protective equipment (such as safety gloves, goggles, and headgear) during installation and maintenance works. Installation/repair technicians may be injured if protective equipment is not properly equipped.
- ▶ Do not use means to accelerate the defrost operation or to clean, other than those recommended by Samsung.
- ▶ Do not pierce or burn.
- ▶ Be aware that refrigerants may not contain an odour.

Safety precautions

INSTALLING THE UNIT

IMPORTANT: When installing the unit, always remember to connect first the refrigerant tubes, then the electrical lines. Always disassemble the electric lines before the refrigerant tubes.

- ▶ Upon receipt, inspect the product to verify that it has not been damaged during transport. If the product appears damaged, DO NOT INSTALL it and immediately report the damage to the carrier or retailer (if the installer or the authorized technician has collected the material from the retailer.)
- ▶ After completing the installation, always carry out a functional test and provide the instructions on how to operate the air to water heat pump to the user.
- ▶ Do not use the air to water heat pump in environments with hazardous substances or close to equipment that release free flames to avoid the occurrence of fires, explosions or injuries.
- ▶ While in installation or relocation of the product, do not mix the refrigerant with other gases including air or unspecified refrigerant. Failure to do so may cause pressure increase to result in rupture or injury.
- ▶ Do not cut or burn the refrigerant container or pipings.
- ▶ Use clean parts such as manifold gauge, vacuum pump, and charging hose for the refrigerant.
- ▶ Installation must be carried out by qualified personnel for handling the refrigerant. Additionally, reference the regulations and laws.
- ▶ Be careful not to let foreign substances (lubricating oil, refrigerant other than R-32, water, etc.) enter the pipings.
- ▶ When mechanical ventilation is required, ventilation openings shall be kept clear of obstruction.
- ▶ For disposal of the product, follow the local laws and regulations.
- ▶ Do not work in a confined place.
- ▶ The work area shall be blocked.
- ▶ The refrigerant pipings shall be installed in the position where there are no substances that may result in corrosion.
- ▶ The following checks shall be performed for installation:
 - The ventilation devices and outlets are operating normally and are not obstructed.
 - Markings and signs on the equipment shall be visible and legible.
- ▶ Upon leakage of the refrigerant, ventilate the room. When the leaked refrigerant is exposed to flame, it may cause generation of toxic gases.
- ▶ Make sure that the work area is safe from flammable substances.
- ▶ To purge air in the refrigerant, be sure to use a vacuum pump.
- ▶ Note that the refrigerant has no odour.
- ▶ The units are not explosion proof so they must be installed with no risk of explosion.
- ▶ This product contains fluorinated gases that contribute to global greenhouse effect. Accordingly, do not vent gases into the atmosphere.
- ▶ For installation with handling the refrigerant(R-32), use dedicated tools and piping materials.
- ▶ Servicing and installation shall be performed as recommended by the manufacturer. In case other skilled persons are joined for servicing, it shall be carried out under supervision of the person who is competent in handling flammable refrigerants.
- ▶ For servicing the units containing flammable refrigerants, safety checks are required to minimise the risk of ignition.

- ▶ Servicing shall be performed following the controlled procedure to minimize the risk of flammable refrigerant or gases.
- ▶ Do not install where there is a risk of combustible gas leakage.
- ▶ Do not place heat sources.
- ▶ Be cautious not to generate a spark as follows:
 - Do not remove the fuses with power on.
 - Do not disconnect the power plug from the wall outlet with power on.
 - It is recommended to locate the outlet in a high position. Place the cords so that they are not tangled.
- ▶ If the indoor unit is not R-32 compatible, an error signal appears and the unit will not operate.
- ▶ After installation, check for leakage. Toxic gas may be generated and if it comes into contact with an ignition source such as fan heater, stove, and cooker. cylinders, make sure that only the refrigerant recovery cylinders are used.
- ▶ Never directly touch any accidental leaking refrigerant.
- ▶ This could result in severe wounds caused by frostbite.

Preparation of fire extinguisher

- ▶ If a hot work is to be done, an appropriate fire extinguishing equipment should have been available.
- ▶ A dry powder or CO₂ fire extinguisher shall be equipped near the charging area.

Ignition sources free

- ▶ Make sure to store the units in a place without continuously operating ignition sources (for example, open flames, an operating gas appliance or an operating electric heater).
- ▶ The service engineers shall not use any ignition sources with the risk of fire or explosion.
- ▶ Potential ignition sources shall be kept away from the work area where the flammable refrigerant can possibly be released to the surrounding.
- ▶ The work area should be checked to ensure that there are no flammable hazards or ignition risks. The “No Smoking” sign shall be attached.
- ▶ Under no circumstances shall potential sources of ignition be used while in detection of leakage.
- ▶ Make sure that the seals or sealing materials have not degraded.
- ▶ Safe parts are the ones with which the worker can work in a flammable atmosphere. Other parts may result in ignition due to leakage.
- ▶ Replace components only with parts specified by Samsung. Other parts may result in the ignition of refrigerant in the atmosphere from a leak.

Area ventilation

- ▶ Make sure that the work area is well ventilated before performing a hot work.
- ▶ Ventilation shall be made even during the work.
- ▶ The ventilation should safely disperse any released gases and preferably expel them into the atmosphere.
- ▶ Ventilation shall be made even during the work.

Safety precautions

Leakage detection methods

- ▶ The leakage detector shall be calibrated in a refrigerant-free area.
- ▶ Make sure that the detector is not a potential source of ignition.
- ▶ The leakage detector shall be set to the LFL (lower flammability limit).
- ▶ The use of detergents containing chlorine shall be avoided for cleaning because the chlorine may react with the refrigerant and corrode the pipings.
- ▶ If leakage is suspected, naked flames shall be removed.
- ▶ If a leakage is found while in brazing, the entire refrigerant shall be recovered from the product or isolated (e.g. using shut-off valves). It shall not be directly released to the environment. Oxygen free nitrogen (OFN) shall be used for purging the system before and during the brazing process.
- ▶ The work area shall be checked with an appropriate refrigerant detector before and during work.
- ▶ Ensure that the leakage detector is appropriate for use with flammable refrigerants.

Labelling

- ▶ The parts shall be labelled to ensure that they have been decommissioned and emptied of refrigerant.
- ▶ The labels shall be dated.
- ▶ Make sure that the labels are affixed on the system to notify it contains flammable refrigerant.

Recovery

- ▶ When removing refrigerant from the system for servicing or decommissioning, it is recommended to remove the entire refrigerant.
- ▶ When transferring refrigerant into cylinders, make sure that only the refrigerant recovery cylinders are used.
- ▶ All cylinders used for the recovered refrigerant shall be labelled.
- ▶ Cylinders shall be equipped with pressure relief valves and shut-off valves in a proper order.
- ▶ The recovery system shall operate normally according to the specified instructions and shall be suitable for refrigerant recovery.
- ▶ In addition, the calibration scales shall operate normally.
- ▶ Hoses shall be equipped with leak-free disconnect couplings.
- ▶ Before starting the recovery, check for the status of the recovery system and sealing state. Consult with the manufacturer if suspected.
- ▶ The recovered refrigerant shall be returned to the supplier in the correct recovery cylinders with the Waste Transfer Note attached.
- ▶ Do not mix refrigerants in the recovery units or cylinders.
- ▶ If compressors or compressor oils are to be removed, make sure that they have been evacuated to the acceptable level to ensure that flammable refrigerant does not remain in the lubricant.
- ▶ The evacuation process shall be performed before sending the compressor to the suppliers.
- ▶ Only the electrical heating to the compressor body is allowed to accelerate the process.
- ▶ Oil shall be drained safely from the system.
- ▶ Never install a motor-driven equipment to prevent ignition.
- ▶ Empty recovery cylinders shall be evacuated and cooled before recovery.

Installation location requirements

- ▶ The unit shall be installed in an open space that is always ventilated.
- ▶ The local gas regulations shall be observed.
- ▶ For installation inside a building (this applies either to indoor or outdoor units installed inside) a minimum room floor area of space conditioned is mandatory according to IEC 60335-2-40:2018 (see the reference table into either the indoor or outdoor unit installation manual).
- ▶ To handle, purge, and dispose the refrigerant, or break into the refrigerant circuit, the worker should have a certificate from an industry-accredited authority.
- ▶ Do not install the indoor unit in the following areas:
 - Area filled with minerals, splashed oil, or steam. It will deteriorate plastic parts, causing failure or leakage.
 - Area that is close to heat sources.
 - Area that produces substances such as sulfuric gas, chlorine gas, acid, and alkali. It may cause corrosion of the pipings and brazed joints.
 - Area that can cause leakage of combustible gas and suspension of carbon fibers, flammable dust, or volatile flammables.
 - Area where refrigerant leaks and settles.
 - Area where animals may urinate on the product. Ammonia may be generated.
- ▶ Do not use the indoor unit for preservation of food items, plants, equipment, and art works. This may cause deterioration of their quality.
- ▶ Do not install the indoor unit if it has any drainage problem.

POWER SUPPLY LINE, FUSE OR CIRCUIT BREAKER

- ▶ Always make sure that the power supply is compliant with current safety standards. Always install the air to water heat pump in compliance with current local safety standards.
- ▶ Always verify that a suitable grounding connection is available.
- ▶ Verify that the voltage and frequency of the power supply comply with the specifications and that the installed power is sufficient to ensure the operation of any other domestic appliance connected to the same electric lines.
- ▶ Always verify that the cut-off and protection switches are suitably dimensioned.
- ▶ Verify that the air to water heat pump is connected to the power supply in accordance with the instructions provided in the wiring diagram included in the manual.
- ▶ Always verify that electric connections (cable entry, section of leads, protections...) are compliant with the electric specifications and with the instructions provided in the wiring scheme. Always verify that all connections comply with the standards applicable to the installation of air to water heat pumps.





CAUTION





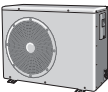







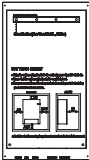

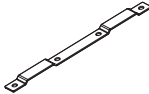
- Make sure that you earth the cables.
 - Do not connect the earth wire to the gas pipe, water pipe, lighting rod or telephone wire. If earthing is not complete, electric shock or fire may occur.
- Install the circuit breaker.
 - If the circuit breaker is not installed, electric shock or fire may occur.
- Make sure that the condensed water dripping from the drain hose runs out properly and safely.
- Install the power cable and communication cable of the indoor and outdoor unit at least 1m away from the electric appliance.

Product specifications

Product compatibility

Line-up			
Outdoor units	Chassis		
	Model Name	AE040RXED** AE060RXED**	AE090RXED**
Indoor units	Hydro Units		
	Model Name	AE090RNYD**	

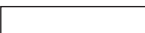
Accessories

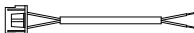
Installation Manual(1)	User Manual(1)	Pattern Sheet(1)
		
Service Valve(2)	Wall Mounting Bracket(1)	Ring band (1)
		
Temperature Sensor for DHW Tank (1x15m, YEL) (1)	Temperature Sensor for Mixing Valve (1x15m, BLU) (1)	Zone Sensor (1x10m, WHT) (2)
		
Sensor holder of zone sensor and mixing valve sensor (3)	Sensor clip for zone sensor and mixing valve sensor (3)	Cable-tie for zone sensor and mixing valve sensor (8)
		
Aluminum tape for zone sensor and mixing valve sensor (3)	Rubber tape for zone sensor and mixing valve sensor (3)	Insulator for for zone sensor and mixing valve sensor (3)
		
Connector Wire - PV Control/Peak power control (1x2 m, RED) (1)		
		

Product specifications

Specifications

Type		Unit	AE090RNYDEG	AE090RNYDGG
Power Source		V/Hz	1ø, 220-240 V~, 50 Hz	3ø, 380-415 V~, 50 Hz
Operation Range [Water]	Cooling	°C	5~25	5~25
	Heating	°C	15~65	15~65
Sound Pressure	Cooling	dB(A)	26	26
	Heating	dB(A)	26	26
Sound Power	Heating	dB(A)	40	40
Dimension (HxWxD)	Net	mm	850 x 510 x 315	850 x 510 x 315
	Gross	mm	1024 x 564 x 426	1024 x 564 x 426
Weight	Net	kg	45.0	46.5
	Gross	kg	55.0	56.0
Connecting Pipe [Refrigerant]	Liquid	Inch	1/4	1/4
	Gas	Inch	5/8	5/8
Service Valve Connecting Pipe [Water]	Inlet	Inch	BSPP male 1 1/4	BSPP male 1 1/4
	Outlet	Inch	BSPP male 1 1/4	BSPP male 1 1/4
Water Pump	Model name	-	UPM3 25-75 180	UPM3 25-75 180
	Maker	-	Grundfos	Grundfos
	Max Vol Folw	m³/h	3.5	3.5
Electric Heater	Input power	W	4,000	6,000
Flow Sensor	Set Point	LPM	7	7
Expansion Vessel	Volume	Liter	8.0	8.0
Pressure relief valve	Size	Inch	BSPP male 1/2	BSPP male 1/2
	Relief Pressure	bar	2.9	2.9
Air-vent Valve	Size	inch	BSPP male 3/8	BSPP male 3/8
Operating Outdoor Temp. Range	Heating	°C	-25 ~ 35	-25 ~ 35
	Cooling		10 ~ 46	10 ~ 46
	DHW Water		-25 ~ 43	-25 ~ 43

* Heat pump operating range of DHW : -25 ~ 35 °C

* At the temperature -25 °C ~ -20 °C, operation is available but capacity cannot be guaranteed.

Typical application examples



WARNING

- The application examples given below are for illustration purposes only.
- When the SAMSUNG Air-to-Water Heat Pump system is used in series with another heat source (e.g. gas boiler), ensure that the return water temperature not exceed 65 °C.
- The unit is only to be used in a closed water system. Application in an open water circuit can lead to excessive corrosion of the water piping.
- SAMSUNG can not be responsible for incorrect or unsafe situations in the water system. Make sure that the boiler, radiators, convectors, solar collectors, UFHs, FCUs, additional pumps, pipings, and controls in the water system are in accordance with relevant local laws and regulations under the installer's responsibility.
- SAMSUNG shall not be held liable for any damage resulting from not observing this rule.
- SAMSUNG do not provide specific water system components such as Pressure relief valve, Air vent valve, buffer tank and etc. Installers and end-users shall consider how to install the above designated components in overall water system depending on the installation conditions. If the components are not installed in appropriate location, the water system can not be operated as designed.

* The below examples are for illustration purposes only.

Application 1: Space heating

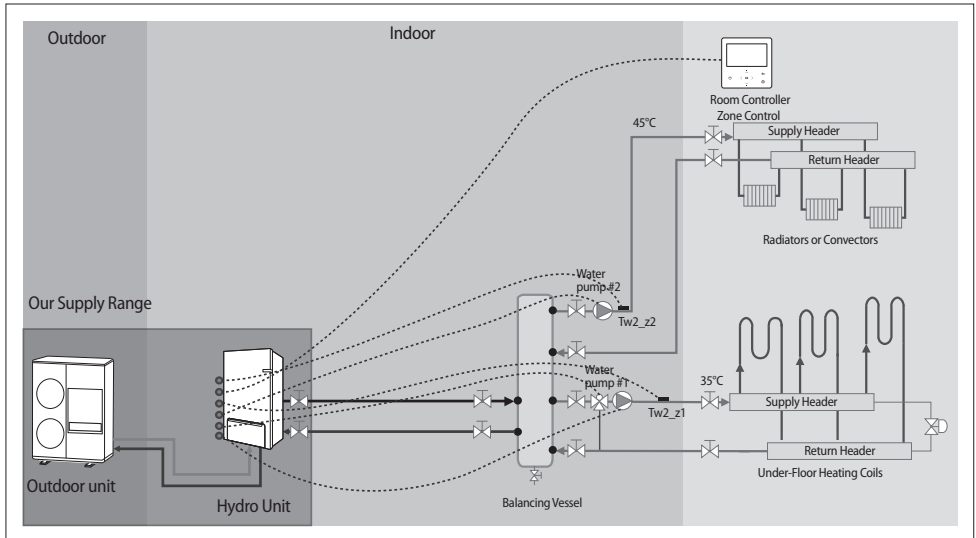

Typical application examples

Application 2: Space heating + water heating

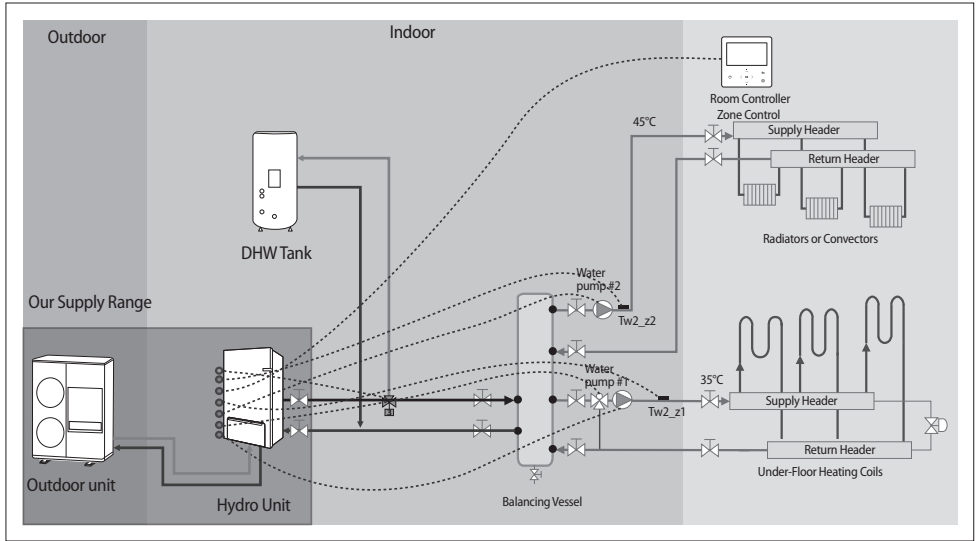

Application 3: Hybrid application (backup boiler and solar panel connected)

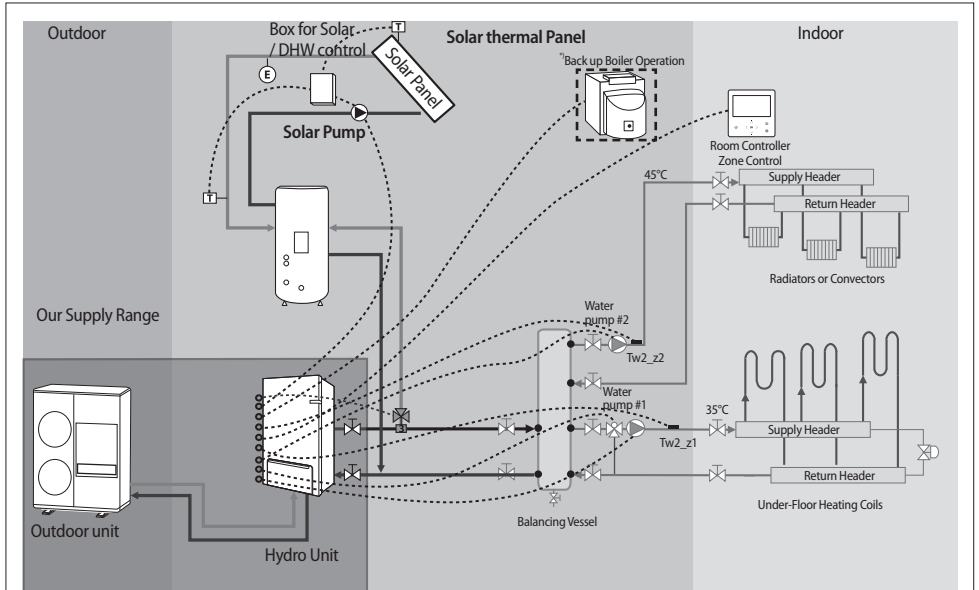

*) We control only the on / off signal of backup boiler according to outdoor temperature.
Backup boiler should be installed with own device according to the field condition.



• Samsung has not responsible for performance and stability of backup boiler.

Main components

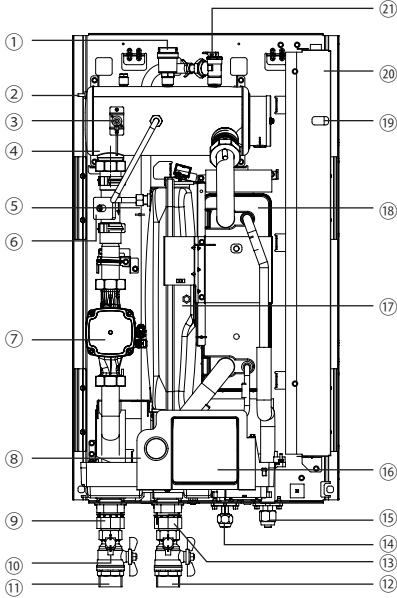

No.	Name	Note
①	Air vent 3/8"	BSPP male 3/8"
②	Backup heater thermal fuse	Thermal cut out 94 °C (+0, -6 °C)
③	Backup heater thermostat	Disc. 75 °C ±4 °C
④	Backup Heater Element	Incoloy 800, 4/6 kW, 230 V AC 50 Hz
⑤	Drain Hose	
⑥	Flow Sensor	5~80L/min
⑦	Water pump	1P-230 V-50 Hz, 26LPM x 43kPa
⑧	Manometer	ø48, 0~4bar
⑨	Water outlet pipe	BSPP male 1 1/4"
⑩	Drain valves	
⑪	Service valve (L)	BSPP male, 1-1/4"
⑫	Service valve (R)	BSPP male, 1-1/4"
⑬	Water inlet pipe	BSPP male 1 1/4"
⑭	Refrigerant pipe	Ø6.35(1/4")
⑮	Refrigerant pipe	ø15.88 (5/8")
⑯	Wired Remote Controller	
⑰	Expansion Vessel	8 Liter, Pre-charge gas : 0.1 MPa, N2, BSPP male, 3/8"
⑱	LED display	
⑳	Control box	
㉑	Pressure relief valve	0.3 MPa, BSPP 1/2"

Functional diagram

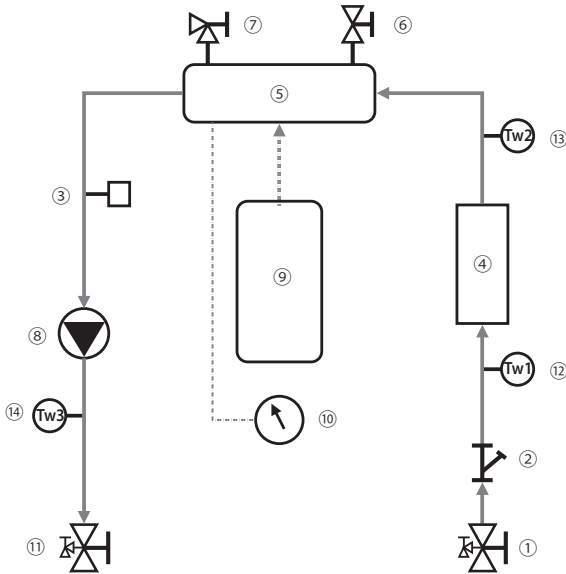

No.	Note
①	Service valve(R)
②	Strainer
③	Flow Sensor
④	Heat exchanger
⑤	Backup heater
⑥	Pressure relief valve
⑦	Air-vent valve
⑧	Variable Speed water pump
⑨	Expansion tank
⑩	Manometer
⑪	Service valve(L)
⑫	Water temp. sensor 1
⑬	Water temp. sensor 2
⑭	Water temp. sensor 3

Dimensional drawing

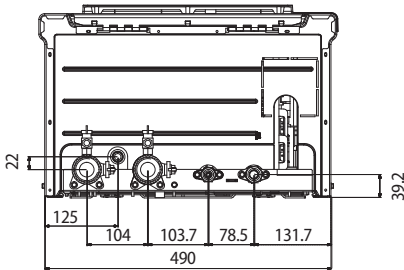
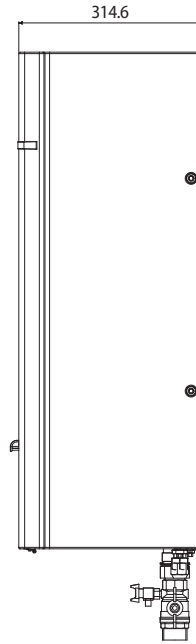
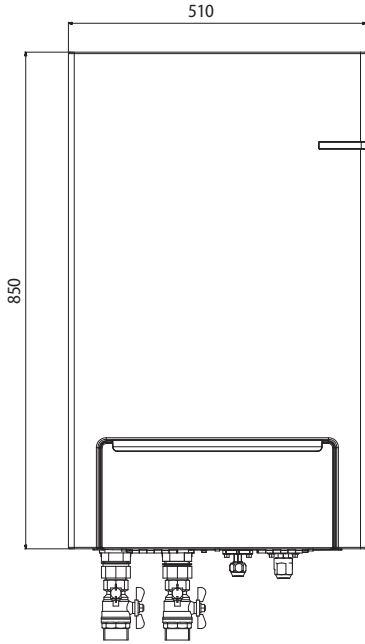

	Gas pipe (O.D.)	Liquid pipe (O.D.)	Water Inlet	Water Outlet
Indoor unit	15.88 mm (5/8 inch)	9kW : 6.35 mm (1/4 inch)	BSPP male 1 1/4"	BSPP male 1 1/4"

Installing the unit

Installation of the indoor unit

The indoor unit should be installed indoors and meet the following conditions.

- ▶ Installation site should be sheltered from frost.
- ▶ In area with suitable space for servicing.
- ▶ A place with adequate ventilation.
- ▶ Where there is no risk of leakage of flammable gases.
- ▶ There is a provision for condensate drain and pressure relief valve blow-off.
- ▶ The wall for installation is a flat, vertical and non-combustible wall, capable of supporting the operation weight of the unit.

Installation space

- ▶ Ensure to leave the appropriate space as indicated in the drawing.
- ▶ Installation site should be secured with adequate ventilation so that the components of hydro unit will not be damaged from overheating.

(Unit : mm)

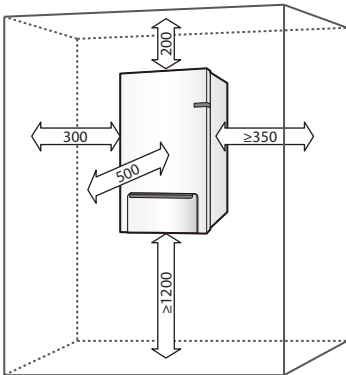

- ▶ Before installing the indoor unit, fix the pattern sheet on the wall. This sheet has a function to take correct position for the wall mounting bracket and screws.

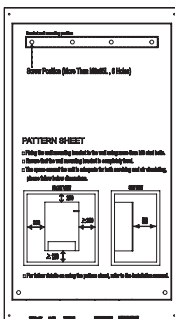

Pattern Sheet

Mounting the indoor unit

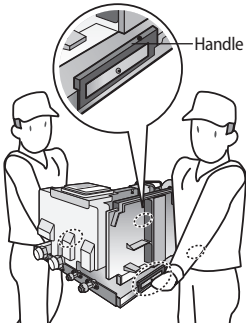

* A minimum of two people should lift the unit by the handles and not by the drain pan or pipe work.

- ▶ Drill 6 holes from the pattern sheet for fixing the wall bracket and unit. After completing holes, detach the pattern sheet.
- ▶ Fix the wall-mount-bracket to the wall using appropriate plugs and screws (Use over M8 6 screws).
- ▶ Hang the indoor unit on an wall-mount-bracket and fix a front cabinet on the unit by using 4 screws.

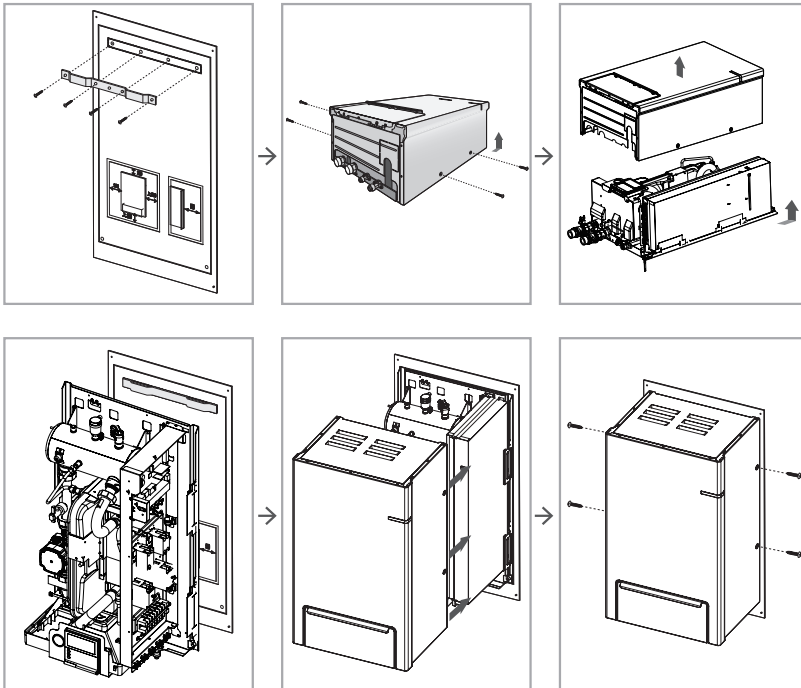

- ▶ Fix screw through base panel of the unit.

Pipe work

Refrigerant pipe work

For all guide lines, specifications regarding refrigerant pipe work between the indoor unit and the outdoor unit, please follow the outdoor unit installation manual.

	Gas pipe (O.D.)	Liquid pipe (O.D.)	Tightening Torque	Final Torque
Indoor unit	15.88 mm (5/8 inch)	9 kW : 6.35 mm (1/4 inch)	400 kg·cm	450 kg·cm
Outdoor unit	15.88 mm (5/8 inch)	4/6/9 kW : 6.35 mm (1/4 inch)	700 kg·cm	750 kg·cm

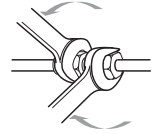

- When connecting the refrigerant pipes, always use 2 wrenches/spanners for tightening or loosening nuts. If not, piping connections can be damaged.

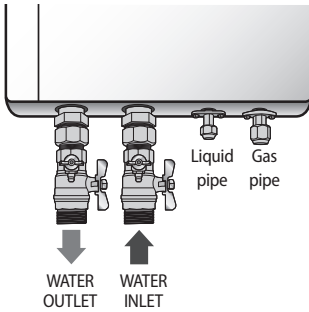

Water pipe work

The hydro unit is equipped with components listed on the table below.

The hot and cold water supply connections are clearly marked on the unit with labels. And service valves are provided.

Whole water plumbing system including Hydro unit shall be installed by a qualified technician and must comply with all relevant European and national regulations.

- ▶ Allowable water pressure of hydro unit is maximum 3.0bar.
- ▶ 2 service valves are provided with the Hydro unit. To facilitate service and maintenance work, install R-Type service valve at the water inlet of the hydro unit and L-Type service valve at the water outlet of the hydro unit.
- ▶ An air-vent valve is integrated on the hydro unit. Please check that air-vent valve is not overtightened so the air-vent valve can release any air out of the system during system operation.

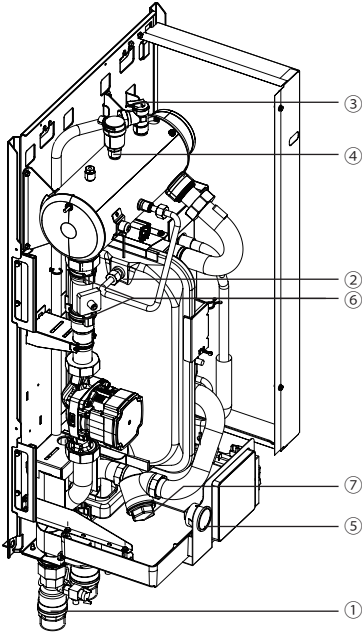

	No.	Name	Tightening Torque	
Hydro unit	①	1.25" BSPP	350 ~ 380 kgf·cm	34 ~ 37 N·m
	②	3/8" BSPP	120 ~ 150 kgf·cm	12 ~ 15 N·m
	③	Pressure relief valve	120 ~ 150 kgf·cm	12 ~ 15 N·m
	④	Air-vent valve	120 ~ 150 kgf·cm	12 ~ 15 N·m
	⑤	Manometer	92~ 102 kgf·cm	9 ~ 10 N·m
	⑥	Flow Sensor	O-ring type	O-ring type
	⑦	Strainer	350 ~ 380 kgf·cm	34 ~ 37 N·m

Pipe work

Flushing and air-purging

When filling water, the following start-up procedure should be followed.

1. All system components and pipes must be tested for the presence of leaks.
2. Make-up water assembly or Flushing unit is recommended for installation and service.
3. Before connecting pipes to the hydro unit, Flush water pipes clean to remove contaminants during 1 hour using a flushing unit or tap water pressure if it is adequate (at 2 to 3bar)
4. Fill water into the hydro unit by opening service valves.
5. Purge the air. (Fill with a flushing unit with sufficient capacity: avoid aerating the water)
6. Circulate for long enough to ensure that all air has been bled from the complete water piping system.

After installations, Commissioning should be performed by qualified representatives.

Unless flushing and air-purging works are performed adequately, it might result in malfunctions.



Flushing unit (or purging cart)

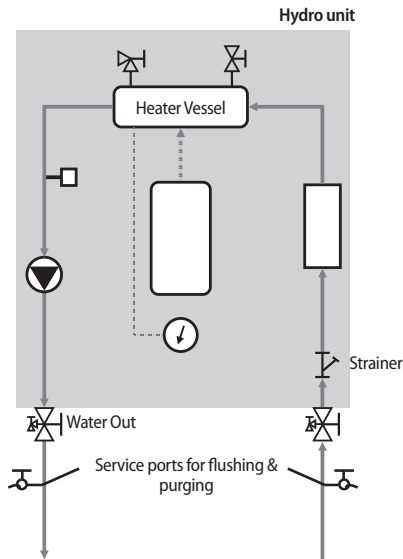

CAUTION

- Check and clean strainer periodically.
- Replace strainer when necessary.
- It is recommended flush the system for 4 hours minimum once a per annum.
- Use chemical cleaning with acid, finish with alkali.
- Install air vents on the top of the system
- Pressure of entering heating water (over 2.0bar)

ESP(External Static Pressure) Diagram

The illustration below shows the external static pressure of the unit depending on the water flow and the pump setting.

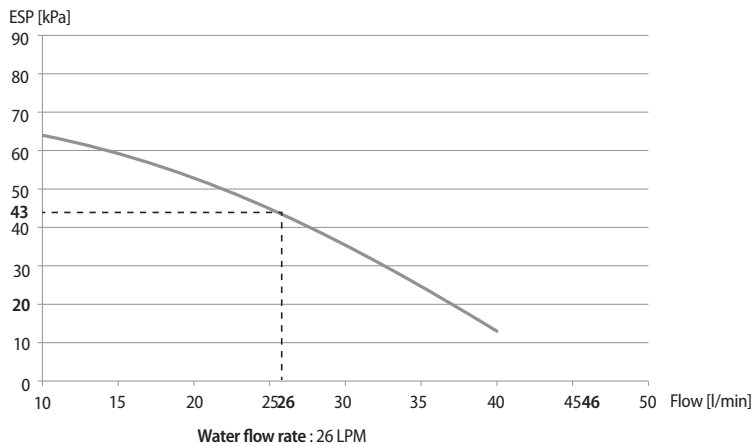

If the pressure loss of total system is over 43 kPa , additional water pump should be installed in series. Otherwise, the flow rate might be decreased, causing insufficient heating or cooling.

When the ESP is not enough, additional pump should be installed. In this case, install the PWM control external type pump (Heating type) additionally.

Connection guide of additional pump

Case 1) INV. pump

Connect the PWM control external type pump to PWM terminal block and power cable to the external contact terminal. Only a single additional inverter pump is allowed (input power 100W).

1. Power supply (For additional INV. Pump)

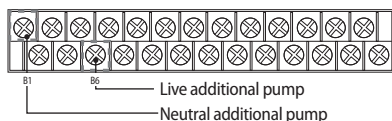

2. PWM control (For additional INV. Pump only), refer to page 24, 25

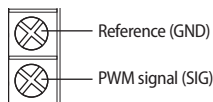

- If there is wrong wiring between PWM and reference, INV. Water Pump may not work or operate incorrectly.

Pipe work

PWM characteristic curve

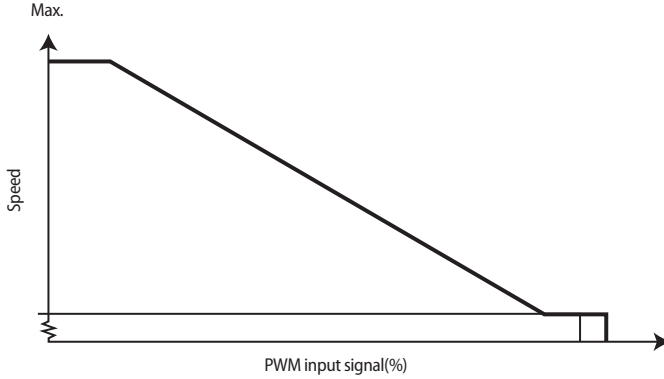

The additional pump should be the same type of product as the above graph.

Recommendation

GRUNDFOS UPM3 25-75

Case 2) AC pump

Only a single additional AC pump is allowed.

1. Power supply (AC Pump)

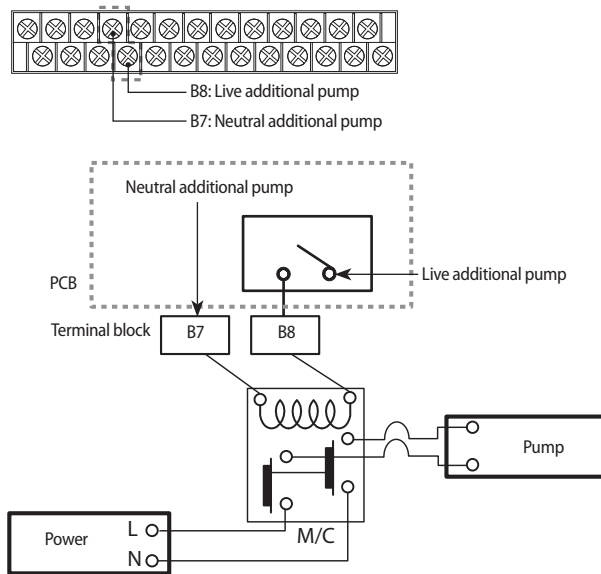

• The maximum allowable current that this terminal block can supply for the additional water pump is 0.1 A.

Setting the pre-pressure of the expansion vessel

When it is required to change the default pre-pressure of the expansion vessel(1 bar), keep in mind the following guidelines:

- ▶ Use only dry nitrogen to set the expansion vessel pre-pressure.
- ▶ Inappropriate setting of the expansion vessel pre-pressure will lead to malfunction of the system. Therefore, the pre-pressure should only be adjusted by a licensed installer.

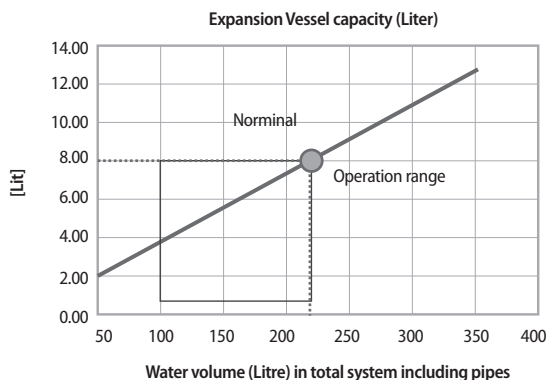

- Water volume of total system (except hydro unit) for reliable performance is minimum 20 liters (AE040/060/090RX**).

Installation height difference ^{a)}	Water volume	
	< 220 Litres	> 220 Litres
< 7 m	No pre-pressure adjustment required.	Actions required: <ul style="list-style-type: none"> • Pre-pressure must be decreased, calculate according to "Calculating the pre-pressure of the expansion vessel". • Check if the water volume is lower than maximum allowed water volume
> 7 m	Actions required: <ul style="list-style-type: none"> • Pre-pressure must be increased, calculate the appropriate value following by "Calculating the pre-pressure of the expansion vessel". • Check if the water volume is lower than maximum allowed water volume 	Expansion vessel of the unit too small for the installation.

- a) Installation height difference: height difference(m) between the highest point of the water circuit and the indoor unit. If the indoor unit is located at the highest point of the installation, the installation height is considered 0 m.

Calculating the pre-pressure of the expansion vessel

The pre-pressure(P_g) to be set depends on the maximum installation height difference(H) and is calculated as below:

$$P_g = (H/10 + 0.3) \text{ bar}$$

Pipe work

Charging water

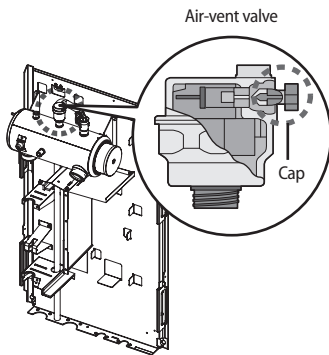
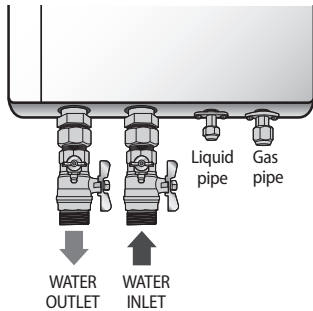

After installation is completed the following procedures shall be used to charge water into the hydro unit.

- ▶ Connect water lines to water connections of hydro unit.
- ▶ The air-vent valve shall be opened at least 2 turns and drain valves shall be closed.
- ▶ Open the service valve in the water supply connection.
- ▶ Water pressure of supply line shall be over 2.0 bar for good charging work.
- ▶ Stop water supply when the pressure gauge of hydro unit indicates 2.0 bar.



- Service space should be secured.
- Water pipe and connections must be cleaned using water.
- If internal water pump capacity is not enough, install external water pump.
- Do not connect electric wire while water charging.
- When initial installation or re-installation required, open the cap to prevent air trap in the unit while charging water.
- The back-up heater vessel shall be full of water before heater is turned on. Confirm if the vessel is empty by opening the pressure relief valve of hydro unit. (OK if water is flowing out)
- It is recommended to install the make-up water assembly to feed small quantities of water to the system automatically, replacing the minor water losses and maintaining the system pressure. This assembly usually consists of a pressure-reducing valve, water filter, check-valve and shut-off valves. In this case, check-valve must be installed to prevent from contaminating public water supply.

Pressure relief valve

A pressure relief valve is integrated on heater vessel of hydro unit and shall work in abnormal condition for protecting the hydro unit.



- The pressure relief valve will operate releasing the pressure by flowing out some water through the drain hose.
- Make certain that the discharged water out of drain pan can not contact any electrical parts.

Piping insulation

The complete water circuit, including all piping must be insulated to prevent condensation forming on the surface of the pipe and heat loss to external environment.

Wiring work



- Field-supplied electrical components such as power switch, circuit breakers, wires, terminal blocks, etc must be properly chosen with compliance with national legislation or regulation.
- Switch off the power supply before making any connections.
- All field wiring and components must be installed by a licensed electrician.
- Use a dedicated power supply.
- All power connections must be protected from dew condensation by thermal insulation.
- The system shall be earthed. Do not earth the unit to a utility pipe, surge absorber or telephone earth. Incomplete earth may cause electrical problems.

Layout of PCB

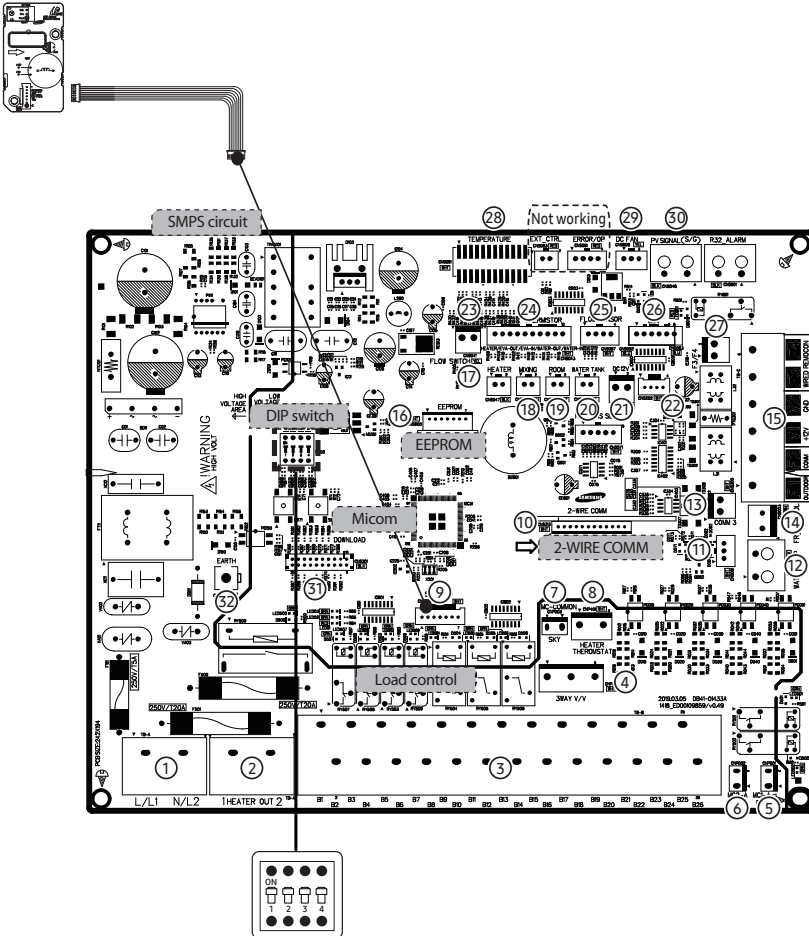

Wiring work

No.	Part code	Part name	Terminal	Terminal description
①	TB-A	AC POWER-IN	#1: L	AC INPUT
			#2: N	AC INPUT
②	TB-A1	HEATER OUT	#1: L	AC OUTPUT
			#2: N	AC OUTPUT
③	TB-B	LOAD CONTROL	#1: N	AC OUTPUT
			#2: MIXING VALVE_CW (L)	AC OUTPUT
			#3: MIXING VALVE_CCW (L)	AC OUTPUT
			#4: BOILER (L)	AC OUTPUT
			#5: N	AC OUTPUT
			#6: L	AC OUTPUT
			#7: N	AC OUTPUT
			#8: WATER PUMP (L)	AC OUTPUT
			#9: 2WAY VALVE1_NO (L)	AC OUTPUT
			#10: 2WAY VALVE1_NC (L) Zone1 Water Pump output(FSV 4061=1)	AC OUTPUT
			#11: N	AC OUTPUT
			#12: L	AC OUTPUT
			#13: 2WAY VALVE2_NO (L)	AC OUTPUT
			#14: 2WAY VALVE2_NC (L) Zone2 Water Pump output(FSV 4061=1)	AC OUTPUT
			#15: N	AC OUTPUT
			#16: L	AC OUTPUT
			#17: 3WAY VALVE_NO (L)	AC OUTPUT
			#18: 3WAY VALVE_NC (L)	AC OUTPUT
			#19: N	AC OUTPUT
			#20: L	AC OUTPUT
			#21: THERMOSTAT1_C (L)	AC INPUT
			#22: THERMOSTAT1_H (L)	AC INPUT
			#23: THERMOSTAT2_C (L)	AC INPUT
			#24: THERMOSTAT2_H (L)	AC INPUT
			#25: SOLAR_N	AC INPUT
			#26: SOLAR_L	AC INPUT
④	CNP501	3WAY VALVE	#1: N	AC OUTPUT
			#2: NO CONNECT	-
			#3: 3WAY VALVE_NO (L)	AC OUTPUT
			#4: NO CONNECT	-
			#5: 3WAY VALVE_NC (L)	AC OUTPUT
⑤	CNP001	MC1-A	#1: L	AC OUTPUT
⑥	CNP002	MC2-A	#1: L	AC OUTPUT
⑦	CNP003	MC-COMMON	#1: N	AC OUTPUT
⑧	CNP401	HEATER THERMOSTAT	#1: N	AC OUTPUT
			#2: NO CONNECT	-
			#3: N	AC OUTPUT

No.	Part code	Part name	Terminal	Terminal description
⑨	CNS201	DISPLAY	#1: DC 12V	DC OUTPUT
			#2: NO CONNECT	-
			#3: NO CONNECT	-
			#4: NO CONNECT	-
			#5: GND	DIGITAL GROUND
			#6: LED CONTROL SIGNAL	DC OUTPUT
			#7: NO CONNECT	-
⑩	CNS313	2-WIRE COMMUNICATION		
⑪	CNS001	WATER PUMP	#1: WATER PUMP PWM SIGNAL	DC OUTPUT
			#2: NO CONNECT	-
			#3: GND	DIGITAL GROUND
⑫	CNS002	WATER PUMP	#1: WATER PUMP PWM SIGNAL	DC OUTPUT
			#2: GND	DIGITAL GROUND
⑬	CNS305	COMMUNICATION3	#1: COM3_RXD	RS485 - COMM.
			#2: COM3_TXD	
⑭	CNS003	FR_CONTROL	#1: FR CONTROL PWM SIGNAL	DIGITAL OUTPUT
			#2: GND	DIGITAL GROUND
⑮	TB-C	COMMUNICATION & DC 12V	#1: COM1 (F1)	RS485 - COMM.
			#2: COM1 (F2)	
			#3: V1 (DC 12V)	DC OUTPUT
			#4: V2 (GND)	DIGITAL GROUND
			#5: COM2 (F3)	WIRED REMOTE CONTROLLER
			#6: COM2 (F4)	
⑯	CNS900	EEPROM	#1: GND	DIGITAL GROUND
			#2: NO CONNECT	-
			#3: DC 5V	DC OUTPUT
			#4: EEPROM_SELECT	DC SIGNAL
			#5: EEPROM_SO	DC SIGNAL
			#6: EEPROM_SI	DC SIGNAL
			#7: EEPROM_CLK	DC SIGNAL
⑰	CNS047	HEATER SENSOR	#1: HEATER TEMP. (10kΩ @ 25 °C)	DIGITAL INPUT
			#2: GND	DIGITAL GROUND
⑱	CNS045	MIXING VALVE SENSOR	#1: MIXING VALVE TEMP. (10kΩ @ 25 °C)	DIGITAL INPUT
			#2: GND	DIGITAL GROUND
⑲	CNS044	ROOM SENSOR	#1: ROOM TEMP. (10kΩ @ 25 °C)	DIGITAL INPUT
			#2: GND	DIGITAL GROUND
⑳	CNS042	WATER TANK SENSOR	#1: WATER TANK TEMP. (200kΩ @ 25 °C)	DIGITAL INPUT
			#2: GND	DIGITAL GROUND
㉑	CNS012	DC 12V	#1: DC 12V	DC OUTPUT
			#2: GND	DIGITAL GROUND
㉒	CNS202	EHS CONVERTER	#1: COM1 (F1)	RS485 - COMM.
			#2: COM1 (F2)	
			#2: GND	DIGITAL GROUND
			#4: DC 12V	DC OUTPUT

Wiring work

No.	Part code	Part name	Terminal	Terminal description
②③	CNS041	Flow Sensor	#1: Flow Sensor	DC INPUT
			#2: GND	DIGITAL GROUND
②④	CNS043	SENSOR	#1: HEATER TEMP. (10kΩ @ 25 °C)	DIGITAL INPUT
			#2: GND	DIGITAL GROUND
			#3: EVA-OUT TEMP. (10kΩ @ 25 °C)	DIGITAL INPUT
			#4: GND	DIGITAL GROUND
			#3: EVA-IN TEMP. (10kΩ @ 25 °C)	DIGITAL INPUT
			#6: GND	DIGITAL GROUND
			#7: WATER-OUT TEMP. (10kΩ @ 25 °C)	DIGITAL INPUT
			#8: GND	DIGITAL GROUND
			#9: WATER-IN TEMP. (10kΩ @ 25 °C)	DIGITAL INPUT
			#10: GND	DIGITAL GROUND
②⑤	CNS057	FLOW SENSOR	#1: DC 5V	DC OUTPUT
			#2: FLOW SENSOR SIGNAL	DIGITAL INPUT
			#3: GND	DIGITAL GROUND
			#4: NO CONNECT	-
②⑥	CNS062/ CNS063	EEV (SPLIT/MONO : Not use)	#1~#4: EEV CONTROL PWM SIGNAL	DC OUTPUT
			#5: DC 12V	DC OUTPUT
			#6: DC 12V (CNS063 ONLY)	DC OUTPUT
②⑦	CNS304	COMMUNICATION	#1: COM2 (F3)	WIRED REMOTE CONTROLLER
			#2: COM2 (F4)	

No.	Part code	Part name	Terminal	Terminal description
⑳	CNS051	DIGITAL INPUT/ OUTPUT	#1: SG READY1 SIGNAL	DC INPUT
			#2: OPTION TEMP.(10kΩ @ 25 °C)	DIGITAL INPUT
			#3: GND	DIGITAL GROUND
			#4: GND	DIGITAL GROUND
			#5: SG READY2 SIGNAL	DC INPUT
			#6: ZONE2 TEMP. (10kΩ @ 25 °C)	DIGITAL INPUT
			#7: GND	DIGITAL GROUND
			#8: GND	DIGITAL GROUND
			#9: DRY CONTACT1 SIGNAL	DC INPUT
			#10: ZONE1 FLOW TEMP. (10kΩ @ 25 °C)	DIGITAL INPUT
			#11: GND	DIGITAL GROUND
			#12: GND	DIGITAL GROUND
			#13: DRY CONTACT2 SIGNAL	DC INPUT
			#14: ZONE2 FLOW TEMP. (10kΩ @ 25 °C)	DIGITAL INPUT
			#15: GND	DIGITAL GROUND
			#16: GND	DIGITAL GROUND
			#17: DRY CONTACT3 SIGNAL	DC INPUT
			#18: NO CONNECT	-
			#19: GND	DIGITAL GROUND
			#20: NO CONNECT	-
			#21: DRY CONTACT4 SIGNAL	DC INPUT
			#22: NO CONNECT	-
			#23: GND	DIGITAL GROUND
			#24: NO CONNECT	-
㉑	CNS062/ CNS063	EEV	#1~#4: EEV CONTROL PWM SIGNAL	DC OUTPUT
			#5: DC 12V	DC OUTPUT
			#6: DC 12V (CNS063 ONLY)	DC OUTPUT
㉒	CNS046	PV/Peak power control SIGNAL	#1: PV(Photovoltaic) Control Signal / Peak power control Signal	DC INPUT
			#2: GND	DIGITAL GROUND
㉓	CNS301	DOWNLOAD		
㉔	CNP101	EARTH	#1: EARTH	EARTH

Wiring work

No.	Part code	Part name	Terminal		Terminal description	
③	Terminal No.	Function	Input /output	Min. / Max. current	Description	Remark
	B2/B3/B5	Mixing valve	AC 230V output	10 mA / 50 mA	Mixing Valve operation(B2: CW, B3: CCW)	Option
	B4/B5	Backup Boiler	AC 230V output	10 mA / 50 mA	Signal output for Backup Boiler(B5: Neutral)	Option
	B7/B8	Additional AC Water Pump	AC 230V output	- / 100 mA	Additional Water pump operation (maximum input power of pump 100W) (B8 : Lived)	Option
	B9/B10/B11/ B12	2Way valve#1 Water pump (Zone1)	AC 230V output	10 mA / 50 mA	2 Way Valve operation for Zone#2 (FCU) (B9 : NO, B10 : NC, B11: Neutral, B12: Lived) Zone1 Water Pump output(FSV 4061=1) (B10:NC, B11:Neutral)	Option
	B13/B14/ B11/B12	2Way valve#2 Water pump (Zone2)	AC 230V output	10 mA / 50 mA	2 Way Valve operation for Zone#2 (FCU) (B13 : NO, B14 : NC, B11: Neutral, B12: Lived) Zone2 Water Pump output(FSV 4061=1) (B14:NC, B15:Neutral)	Option
	B15/B16/ B17/B18	3Way valve	AC 230V output	10 mA / 50 mA	3 Way Valve operation for DHW (B17 : NO, B18 : NC, B15: Neutral, B16: Lived)	Option
	B19/B20	Thermostats	AC 230V output	- / 22 mA	Power to external thermostat(s) (B20: Lived)	Option
	B21/B22	Thermostat 1	AC 230V input	- / 22 mA	Thermostat for zone#1 (UFH) Cooling(B21)/ Heating(B22) Signal	Option
	B23/B24	Thermostat 2	AC 230V input	- / 22 mA	Thermostat for zone#2 (FCU) Cooling(B23)/ Heating(B24) Signal	Option
B25/B26	Solar Pump	AC 230V input	- / 22 mA	Signal input from Solar Pump / DHW Thermostat (B26 :Lived)	Option	

Wiring diagram 1-Phase

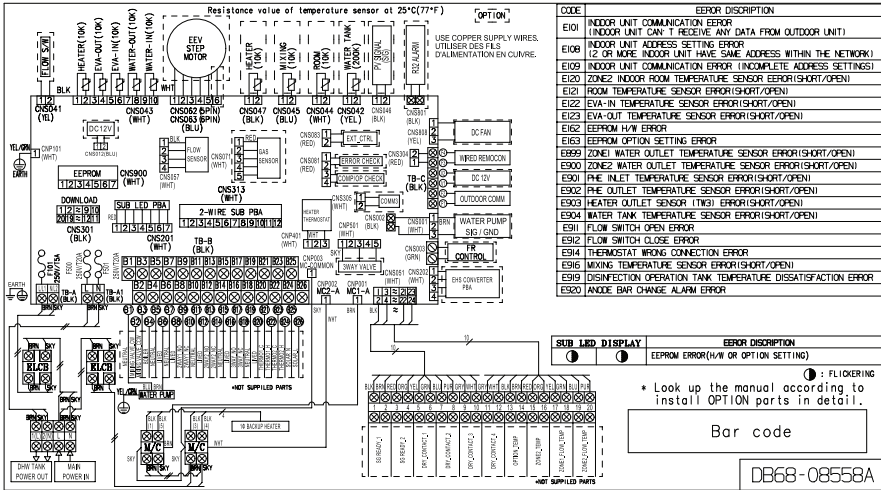

Wiring diagram 3-Phase

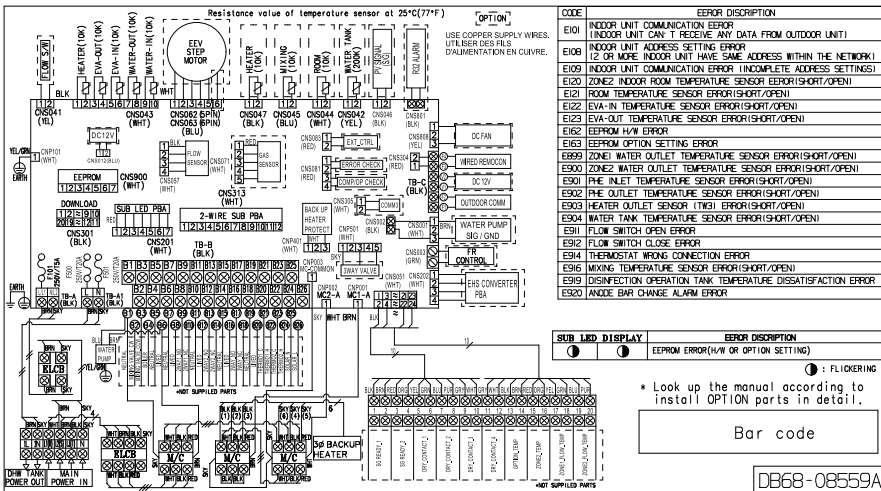

* It does not support external input(CNS083)/output(CNS081) signal function

Wiring work

Selecting solderless ring terminal

- ▶ Select a solderless ring terminal of a connecting power cable based on a nominal dimensions for cable.
- ▶ Cover a solderless ring terminal and a connector part of the power cable and then connect it.

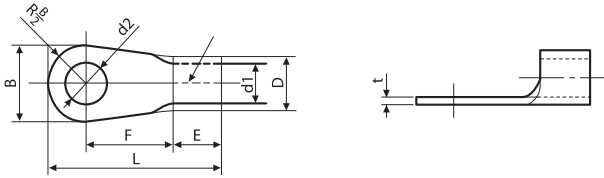

Nominal dimensions for cable (mm ²)	Nominal dimensions for screw (mm)	B		D		d1		E	F	L	d2		t
		Standard dimension (mm)	Allowance (mm)	Standard dimension (mm)	Allowance (mm)	Standard dimension (mm)	Allowance (mm)	Min.	Min.	Max.	Standard dimension (mm)	Allowance (mm)	Min.
4/6	4	9.5	±0.2	5.6	+0.3 -0.2	3.4	±0.2	6	5	20	4.3	+0.2 0	0.9
	8	15							9	28.5	8.4		
10	8	15	±0.2	7.1	+0.3 -0.2	4.5	±0.2	7.9	9	30	8.4	+0.4 0	1.15
16	8	16	±0.2	9	+0.3 -0.2	5.8	±0.2	9.5	13	33	8.4	+0.4 0	1.45
25	8	12	±0.3	11.5	+0.5 -0.2	7.7	±0.2	11	15	34	8.4	+0.4 0	1.7
	8	16.5							13		8.4		
35	8	16	±0.3	13.3	+0.5 -0.2	9.4	±0.2	12.5	13	38	8.4	+0.4 0	1.8
	8	22			+0.5 -0.2				13	43	8.4	+0.4 0	
50	8	22	±0.3	13.5	+0.5 -0.2	11.4	±0.3	17.5	14	50	8.4	+0.4 0	1.8
70	8	24	±0.4	17.5	+0.5 -0.4	13.3	±0.4	18.5	20	51	8.4	+0.4 0	2

Torque requirements

CONTROL-KIT PBA

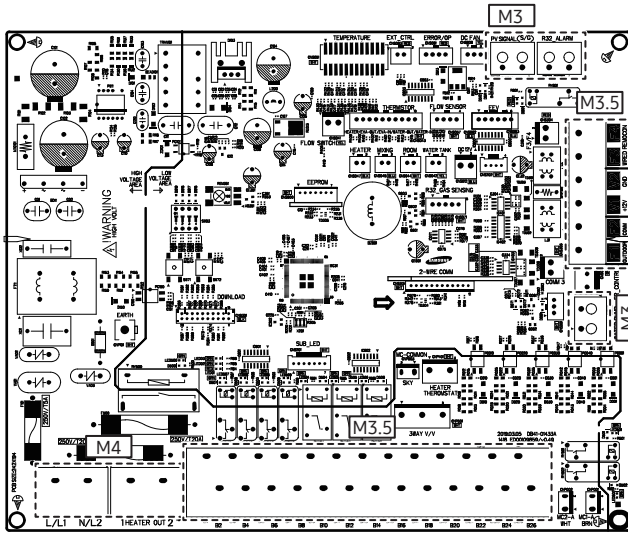

Screw size	Tightening torque (N·m)	Part	Terminal code	Remarks
M3	0.5~0.75	Control Kit PBA 2P Terminal Block	PV/Peak power control SIGNAL	Dry contact input
			R-32 ALARM	Dry contact output
			WATER PUMP	PWM signal output
M3.5	0.8~1.2	Control Kit PBA 6P Terminal Block	F1, F2, V1, V2, F3, F4	DC 5V/12V output
		Control Kit PBA 26P Terminal Block	B1 ~ B26	AC 220V-240V power input/output
M4	1.2~1.8	Control Kit PBA 2P Terminal Block	TB-A (L/11 N/N1)	AC 220V-240V power input
			TB-A1 (HEATER OUT)	AC 220V-240V power output

Wiring work

C-BOX: SINGLE PHASE

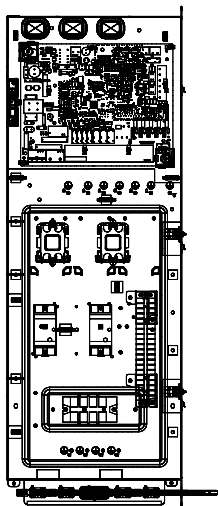

C-BOX: 3 PHASE

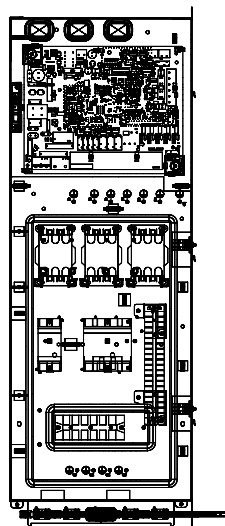

Screw size	Tightening torque (N·m)	Part	Terminal code	Remarks
M3	0.5~0.75	20P Terminal Block	1~20	Digital input/output
M5	2.0~2.9	Magnetic contactor 2P Single phase	-	AC 220V-240V power input/output
		Magnetic contactor 3P 3phase	-	AC 380V-415V power input/output
		ELCB 2P Single phase	-	AC 220V-240V power input/output
		ELCB 4P 3 phase	-	AC 380V-415V power input/output
		Terminal block 4P Single phase	1(L), 2(N)	AC220-240V Power output
			L, N	AC220-240V Power input
Terminal block 6P 3 phase	1(L), 2(N)	AC220-240V Power output		
	L1(R), L2(S), L3(T), N	AC 380V-415V power input		

Grounding work

- ▶ Grounding must be done by a qualified installer for your safety.

Grounding the power cable

- ▶ The standard of grounding may vary according to the rated voltage and installation place of a heat pump.
- ▶ Ground the power cable according to the following.

Installation place Power condition	High humidity	Average humidity	Low humidity
Electrical potential of lower than 150V		Perform the grounding work 3. ^{Note 1)}	Perform the grounding work 3 if possible for your safety. ^{Note 1)}
Electrical potential of higher than 150V	Must perform the grounding work 3. ^{Note 1)} (In case of installing circuit breaker)		

※ **Note 1) Grounding work 3**

- Grounding must be done by your installation specialist.
- Check if the grounding resistance is lower than 100 Ω.

When installing a circuit breaker that can cut the electric circuit in case of a short circuit, the allowable grounding resistance can be 30~500 Ω.

Wiring work

Checking correct grounding

If the power distribution circuit does not have a grounding or the grounding does not comply with specifications, an grounding electrode must be installed. The corresponding accessories are not supplied with the Air to Water Heat pump.

1. Select an grounding electrode that complies with the specifications given in the illustration.

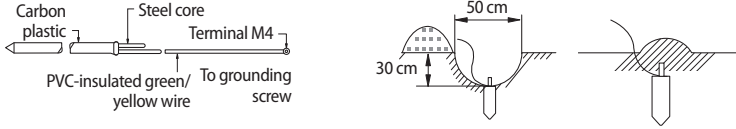

2. Connect the flexible hose to the flexible hose port.
 - ▶ In damp hard soil rather than loose sandy or gravel soil that has a higher grounding resistance.
 - ▶ Away from underground structures or facilities, such as gas pipes, water pipes, telephone lines and underground cables.
 - ▶ At least two metres away from a lightning conductor grounding electrode and its cable.



• The grounding wire for the telephone line cannot be used to ground the Air to Water Heat pump.

3. Finish wrapping insulating tape around the rest of the pipes leading to the outdoor unit.
4. Install a green/yellow coloured grounding wire :
 - ▶ If the grounding wire is too short, connect an extension lead, in a mechanical way and wrapping it with insulating tape (do not bury the connection).
 - ▶ Secure the grounding wire in position with staples.



• If the grounding electrode is installed in an area of heavy traffic, its wire must be connected securely.

5. Carefully check the installation, by measuring the grounding resistance with a ground resistance tester. If the resistance is above required level, drive the electrode deeper into the ground or increase the number of grounding electrodes.
6. Connect the grounding wire to the electrical component box inside of the outdoor unit.

Connection of the power supply and communication cable

Model	Description	No. of wires	Max. A	Thickness	Supply Scope
AE090RNYDEG	1 Phase main power	2 + ground	18.6A	4.0mm ² ↑ H05RN-F or H07RN-F	Field supply (220-240Vac, Input)
	Communication	2	0.1A	0.75mm ² ↑ H05RN-F or H07RN-F	Field wiring (7Vdc, data)
AE090RNYDGG	3 Phase power	4 + ground	9.2 A	2.5mm ² ↑ H07RN-F	Field supply (380-415Vac, Input)
	Communication	2	0.1A	0.75mm ² ↑ H05RN-F or H07RN-F	Field wiring (7Vdc, data)

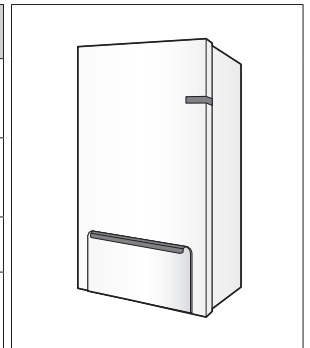

* When you use inlet hole through the cabinet top positions for power/communication wires, please fix the wire by using mount tie of the cabinet right.

2 wires for communication cable

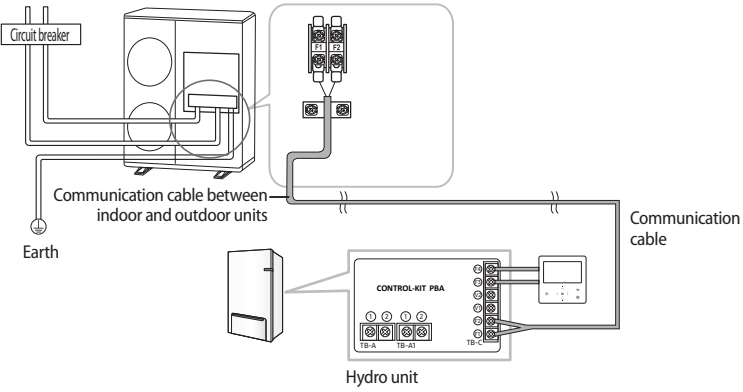

Communication cable connection

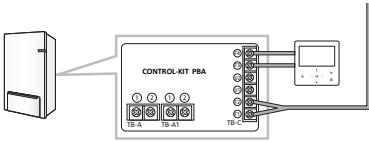

1. 1 phase product

1 Φ , 220-240Vac

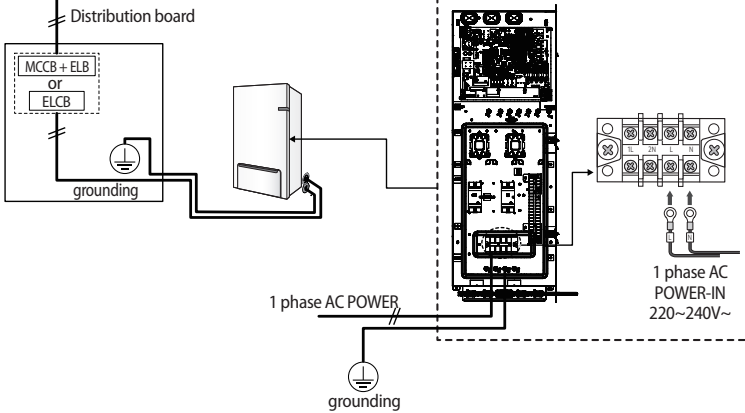

Wiring work

2. 3 phase product

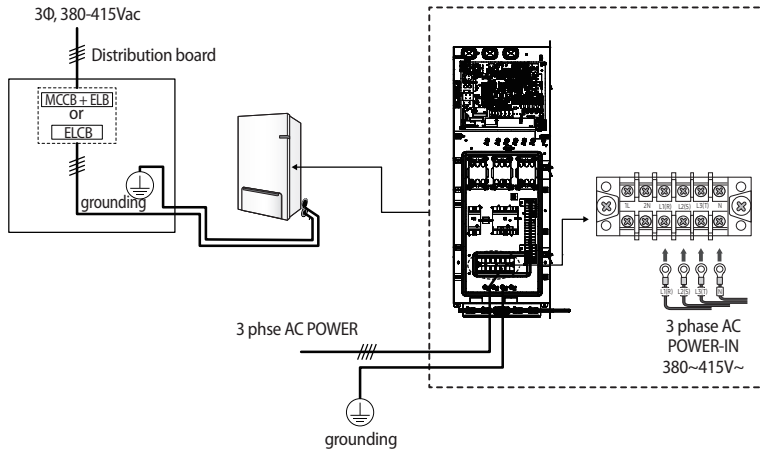

- If the supply cable is damaged, it must be replaced by a special cable or assembly available from the manufacturer or installer.
- Circuit Breaker (ELCB, ELB, MCCB etc.) for outdoor and indoor units shall be installed by installers because they are not sub-parts in the units. But you don't need to install for hydro unit (Built-in ELCB).
- It cause damage to chassis, PCB parts if the main power is not connected correctly. You should make certain that R, S, T is connected correctly before turning on the main power. (3 phase models only)

- * ELCB : Earth leakage circuit breaker
- ELB : Earth leakage breaker
- MCCB : Molded case circuit breaker

Connecting the power terminal

- ▶ Connect the cables to the terminal board using the solderless ring terminal.
- ▶ Use certified and reliable cables.
- ▶ Connect the cables with the torque chart as below.
- ▶ If the terminal is loose, fire may occur caused by arc. If the terminal is connected too firmly, the terminal may be damaged.
- ▶ External force should not be applied to the terminal block and wires.
- ▶ The cable ties to fasten the wire should be an incombustible material, V0 or above. (The cable ties should be used to fasten the power wire and they are supplied with the unit.)

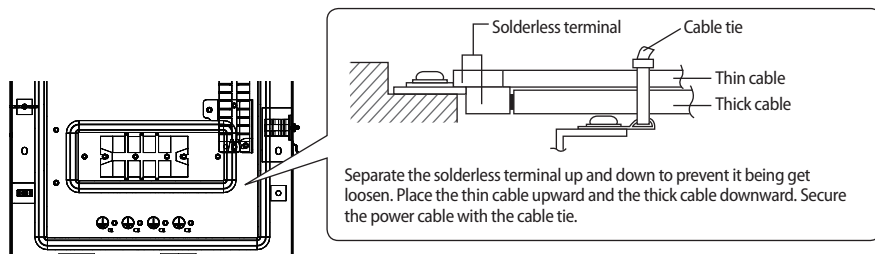

Tightening Torque (kgf · cm)

M3	5~7.5
M5	20 ~ 30

Connection of the backup heater power supply



Do not use a power supply shared by other appliances. Each components for outdoor unit, indoor unit, backup heater and booster heater has the dedicated power supply.

Model	Heater capacity (kW)	ELCB capacity (A)
AE090RNYDEG	4	30
AE090RNYDGG	6	20

* Circuit Breaker(ELCB, ELB, MCCB etc.)s written above are already included in the hydro unit.

ELCB : Earth leakage circuit breaker

ELB : Earth leakage breaker

MCCB : Molded case circuit breaker

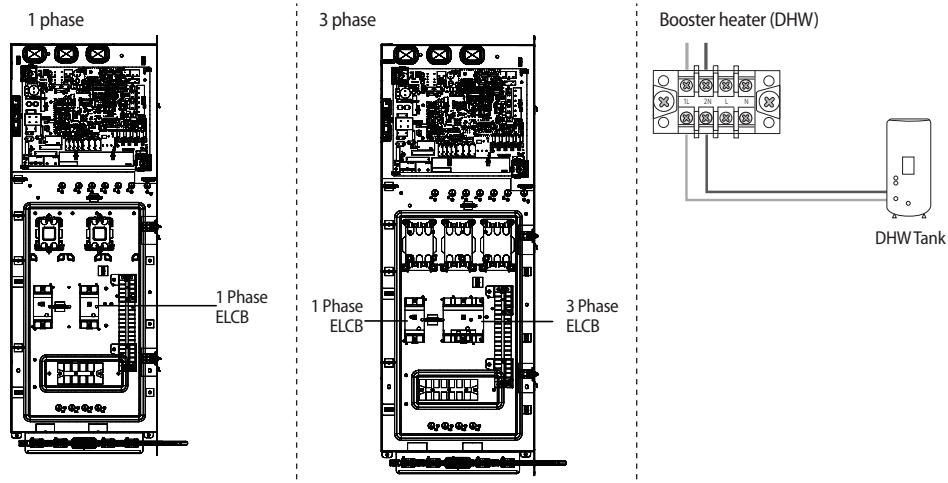

Wiring work

Connection of the thermostat

Description	No. of wires	Max. current	Thickness	Supply Scope
Room Thermostat	4	22mA	> 0.75 mm ² , H05RN-F or H07RH-F	Field supply (220-240V~, Input)

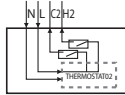
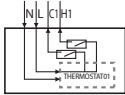
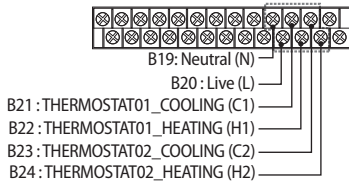

- Before the installation, hydro unit should be turned off.
- Using the appropriate equipment to correct position of terminal block as shown on the diagram.
- Determine the thermostat type.
 - Normal OPEN or Normal CLOSED.
 - Contact signal must be "L". When installing two thermostats, thermostat2 is prior to thermostat1.



• Product will not operate when signal for cooling and heating mode is inputted at the same time.

Connection of the 2-way valve

Description	No. of wires	Min. / Max. current	Thickness	Supply Scope
Motorized 2-way valve to shut off UFH loops during cooling.	2+ground	10mA / 50mA	> 0.75 mm ² , H05RN-F or H07RH-F	Field supply (220-240V~, Output)

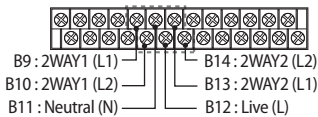

* Connection of 2 wires 2-way valve

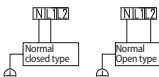

In case of normal closed type

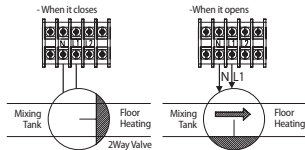

In case of normal open type

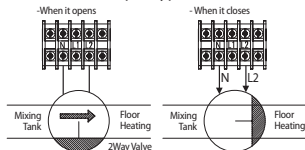

2-way motorized valve

- ▶ When outlet water temperature reach to lower than 16 °C in cooling mode, UFH loops will be closed.
- ▶ 220-240V~
- ▶ 2 wires(Normal Open or Normal Close)

- Before the installation, hydro unit should be turned off.
- Using the appropriate equipment to correct position of terminal block as shown on the diagram.
- Determine the motorized valve type.
 - Normal OPEN or Normal CLOSED.



• There are 2 types of 2-way valve, normal open type and normal closed type. Make sure to connect terminals to right positions of terminal block. As detailed on the wiring diagram and illustrations above.

Connection of the water pump for 2-zone control (FSV 4061=1)

- ▶ Zone1 water pump connection: B10(L1) + B11(N)
- ▶ Zone2 water pump connection: B14(L1) + B15(N)

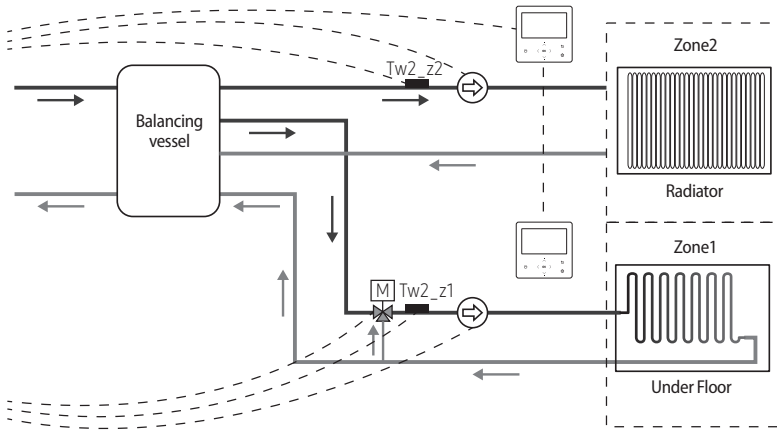

Wiring work

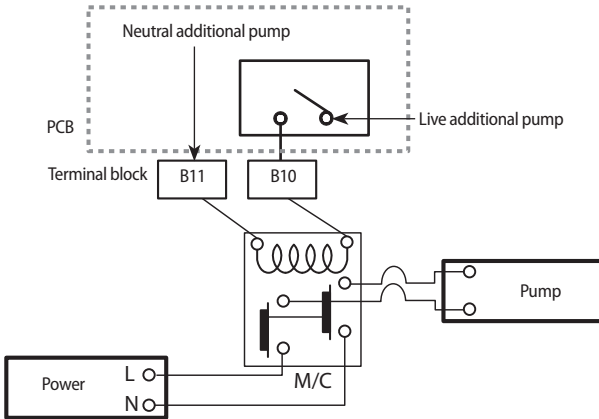
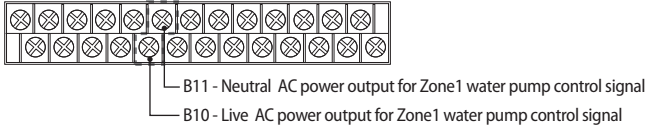

• The maximum allowable current that this terminal block can supply for the additional water pump is 50mA.

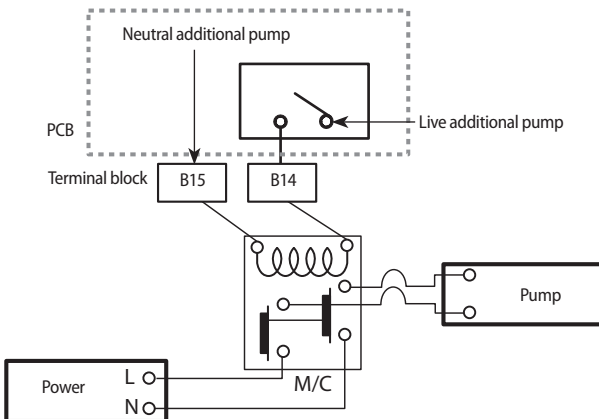
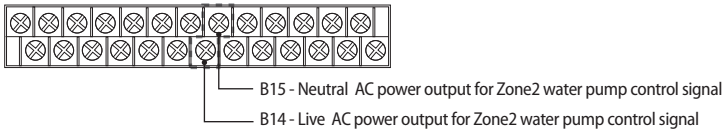

• The maximum allowable current that this terminal block can supply for the additional water pump is 50mA.

Connection of the 3-way valve

Description	No. of wires	Mini. / Max. current	Thickness	Supply Scope
Diverting type 3way valve	4	10mA / 50mA	> 0.75 mm ² , H05RN-F or H07RN-F	Field supply (220-240V~, Input)

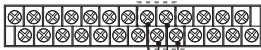

B15 : Neutral (N)
B16 : Live (L)
B17 : 3WAY (L1)
B18 : 3WAY (L2)

Status	L1	L2
A (Initial)	OFF	ON
B	ON	OFF

3-way diverting valve for water tank

► When cooling operating mode, floor heating loops will be closed.

► 220-240V~

1. Before the installation, hydro unit should be turned off.
2. Using the appropriate equipment to correct position of terminal block as shown on the diagram.
3. Make sure what type of 3 way V/V you use.

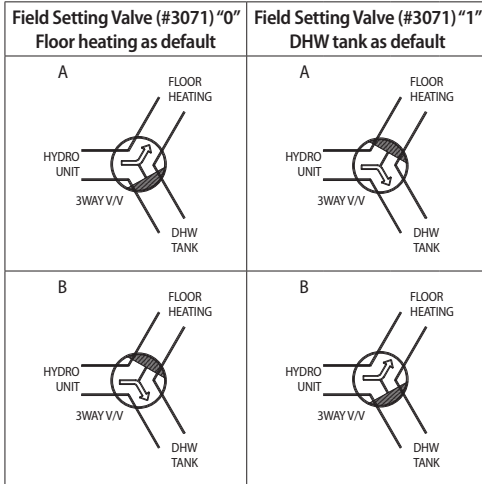

Wiring work

Connection of the back-up boiler

Description	No. of wires	Mini. / Max. current	Thickness	Supply Scope
Back-up Boiler	2+ground	10mA / 50mA	0.75mm ² H05RN-F or H07RN-F	Field supply (220-240V~, Input)

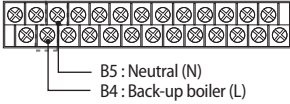

When it set back up boiler on the hydro unit (relay off)

When it order to back up boiler operates (relay on)

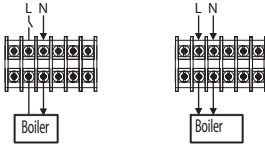

1. Before the installation, hydro unit should be turned off.
 2. Using the appropriate equipment to correct position of terminal block as shown on the diagram.
 3. Make sure EXT-CTRL signal of back up boiler must be 230Vac.
 - Do not connect supply power of back up boiler directly.
- * Heat pump does not work when the Back-up boiler operates.

Connecting for external contact functions

Screw size	Tightening torque (N·m)	Part	Terminal code
M3	0.5~0.75	20P Terminal block	1~20

Connecting external sensors for zone control

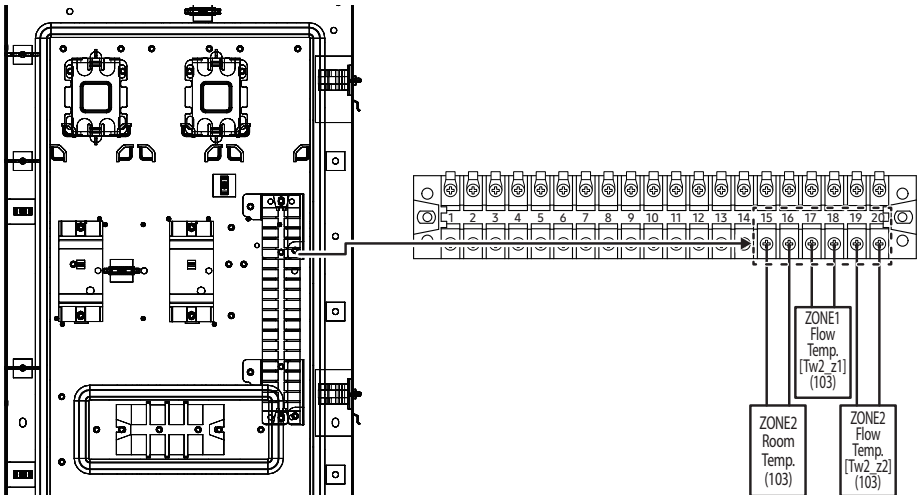

• When connecting sensors, use a Thermistor with the specifications of 10 kΩ at 25 °C, B constant = 3435 k.

Connecting for smart grid ready control

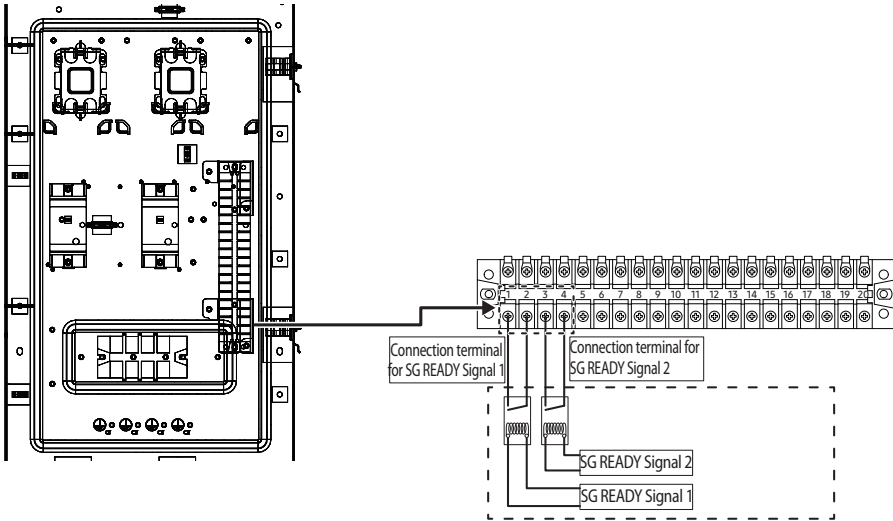

SG READY Signal 1	SG READY Signal 2	Product operation
Short	Open	Forced thermo off operation
Open	Open	Normal operation
Open	Short	Heating / DHW setting temperature 1step-up operation
Short	Short	Heating / DHW setting temperature 2step-up operation



CAUTION

- These parts are optional and not included with the product.
- Make sure to connect to non-power on/off contacts.

Self-test mode of wired remote controller

Use of self-test mode

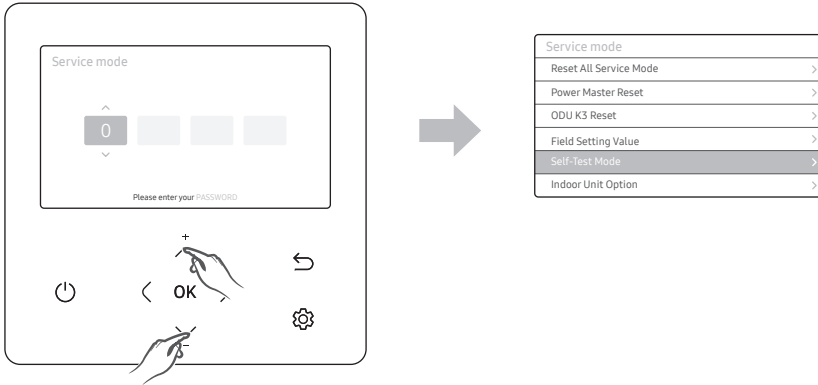

1. If you want to use the various additional functions for your Wired Remote Controller, press the \wedge and \vee buttons at the same time for more than 3 seconds.
 - ▶ The password entry screen appears.
2. Enter the password, "0202," and then press the OK button.
- ▶ The settings screen for installation/service mode appears.
3. Select Self-Test Mode in Service Mode.
4. Self-Test Mode consists of Self-Test Display that shows operation value status and menus that can turn each component on or off.

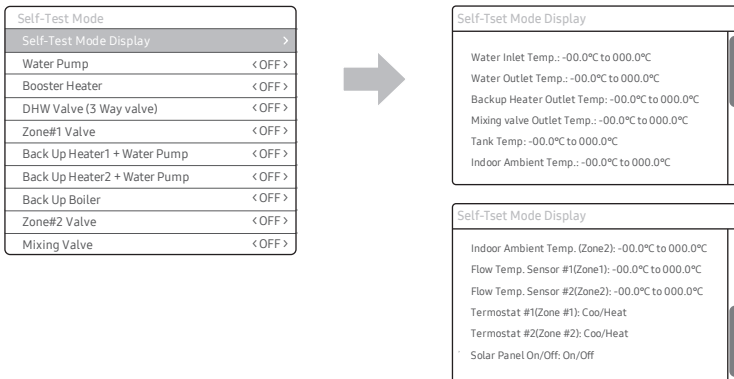

Troubleshooting

If the unit has some problem to work properly, the LED on hydro unit will flash and some error codes will be displayed on the controller.

The following table described the explanation of error codes on the LCD display.

Thermistor

- ▶ Check its resistance. 10kohm@25 °C (Hydro unit), 200kohm@25 °C (DHW Tank, Solar)
- ▶ Check its location as shown at the diagram.
- ▶ Check its contact status with pipe.
- ▶ Final solution is to change parts

Display	Explanation
120	Short- or open-circuit error of the room temperature sensor of the Zone 2 indoor unit (detected only when the room thermostat is used)
121	Short- or open-circuit error of the room temperature sensor of the Zone 1 indoor unit (detected only when the room thermostat is used)
653	Wired remote controller thermistor SHORT or OPEN
899	Zone1 Water Outlet Themistor SHORT or OPEN
900	Zone2 Water Outlet Themistor SHORT or OPEN
901	Water Inlet thermistor SHORT or OPEN
902	PHE Outlet thermistor SHORT or OPEN
903	Water Outlet thermistor SHORT or OPEN
904	Water TANK thermistor SHORT or OPEN
916	Mixing Valve thermistor SHORT or OPEN

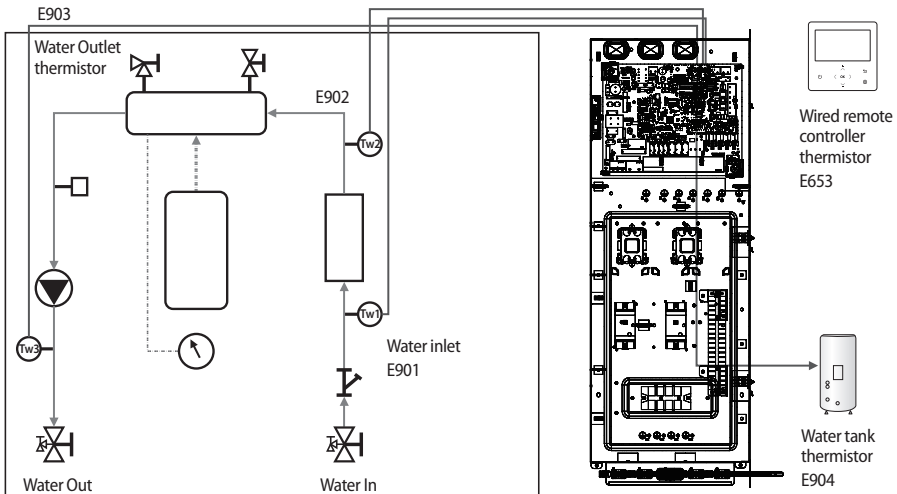

Troubleshooting

Communication

Display	Explanation
E01	Communication error between remote controller and the Hydro unit
E04	Tracking error between remote controller and the Hydro unit
E54	Memory(EEPROM) Read/Write Error(Wired remote controller data error)

E601, E604

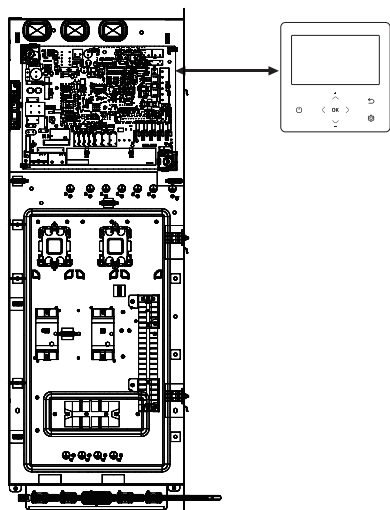

E654

MEMORY(EEPROM) Read/Write Error (Wired controller data error)

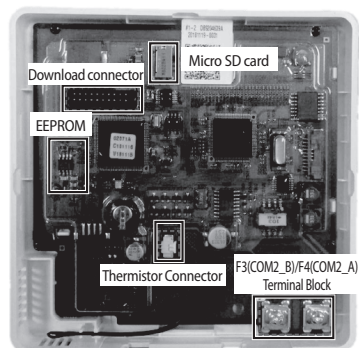

Water pump & Flow Sensor

Display	Explanation
9 11	Low flow rate error • in case of low flow rate in 30 sec during water pump signals is ON(Starting) • in case of low flow rate in 15 sec during water pump signals is ON(After starting)
9 12	Normal flow rate error • in case of normal flow rate in 10min during water pump signal is OFF

E911

- ▶ Water pump ON (Low flow rate) : NOT enough water flow

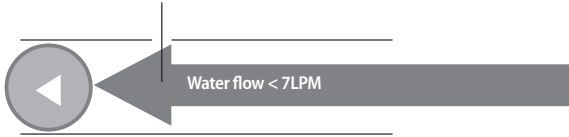

E912

- ▶ Water pump OFF (Normal flow rate)

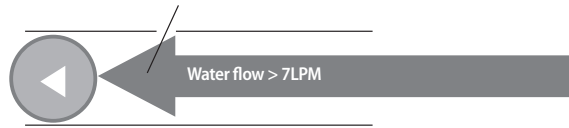

Water flow range

	Water flow rates (LPM)	
	Min	Max
Outdoor unit capacity	7	48

DHW tank

DHW tank should be purchased separately (not supplied).

Safety information

Before installing an DHW Tank, please read this manual thoroughly to ensure that you know how to safely and efficiently install a new appliance.



WARNING

- If you don't follow the safety precautions, you may get the risk of serious wound or death.

- ▶ The installation must be done by the manufacturer or its service agent or a qualified person in order to avoid a hazard.
 - Installation by an unqualified person may cause a water leakage, electric shock or fire and so on.
- ▶ The electric work must be done by service agent or qualified persons according to national wiring regulations and use only rated cable.
 - Use certified power cable in the market suggested here and do electric work according to installation manual otherwise, electric shock or fire may occur.
- ▶ Install the outdoor unit correctly according to the installation manual.
 - An incorrect installation may cause a water leakage, electric shock or fire and so on.
- ▶ Manufacturer is not responsible for accidents due to incorrect installation.
- ▶ Use certified parts in the market and supplied parts from the factory.
 - All wiring, components and materials to be procured on the site must comply with the applicable local and national codes. If you don't use the certified parts and tools, it can cause trouble to the Air to Water Heat pump and bring into injury.
- ▶ Install the DHW Tank on a hard and even place that can support its weight.
 - If the place cannot support its weight, the outdoor unit may fall down and it may cause injury.
- ▶ Fix the outdoor unit securely on its foundation or it might fall over by strong wind or an earthquake.
 - If the outdoor unit is not properly fixed, it turns over and accidents may occur.
- ▶ Secure power cable with a conduit, which is accessory part for DHW tank, not to be pulled out by external force.
 - If fixing is incomplete, it can cause trouble with a heat generation, electric shock or fire and so on.

GENERAL INFORMATION

- ▶ The piping, valves and system configuration of DHW tank system should be followed a relevant local or national regulations.
- ▶ A pressure relief valve should be installed according to the use pressure of DHW Tank.
- ▶ The electrical box must be opened by a licensed electrician.
- ▶ Switch off the power supply before opening the electrical box lid.
- ▶ Make sure that the installation location of DHW tank system including piping and valves is frost free.



CAUTION

- DHW Tank shall be located and installed indoors (garage, utility room, boiler room).

Piping diagram



- The product must be installed without any water leakage.
- Please verify that the DHW tank and other components are properly installed and reinstall them if necessary.
 - Use certified components and the correct tools.
 - Make sure there is sufficient installation space.

OVERVIEW

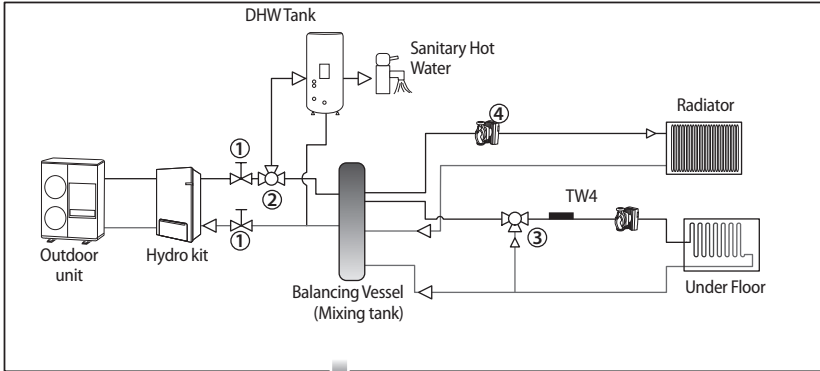

Sanitary warm water Tank Diagram (Field Scope)

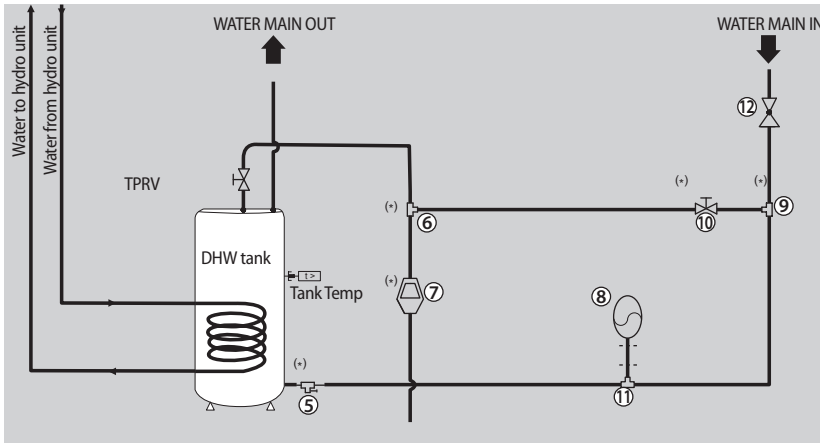

DHW tank

No.	Note	No.	Note
①	Service valve	⑧	Expansion vessel
②	3 way diverting valve	⑨	T-Joint
③	Mixing Valve	⑩	Expansion relief Valve
④	Circulation Pump	⑪	T-Joint
⑤	Drain Valve	⑫	Pressure reducing valve with integrated check valve and strainer
⑥	T-Joint	TW4	Temperature Sensor for Mixing Valve
⑦	Tundish	Tank Temp	Temperature sensor for DHW tank

* The table above contains the different components of the functional diagrams.

System configuration

- ▶ For the reliable performance and durability, all parts as listed below, including a relief valve, an expansion vessel, a drain valve and pressure reducing valve, should be installed according to each national or regional standards. They are not supplied by SAMSUNG.
 - Pressure relief valve
 - Expansion vessel
 - Drain valve
 - Tundish
 - Expansion relief valve
 - Pressure reducing valve
- ▶ Screw the thermistor socket in the threaded thermistor hole in the tank, use a thread sealant such as Teflon or similar to make water tight.
- ▶ Apply contact glue to the thermistor and insert the thermistor as deep as possible in the thermistor socket. Fix using the nut provided.

Switch box layout

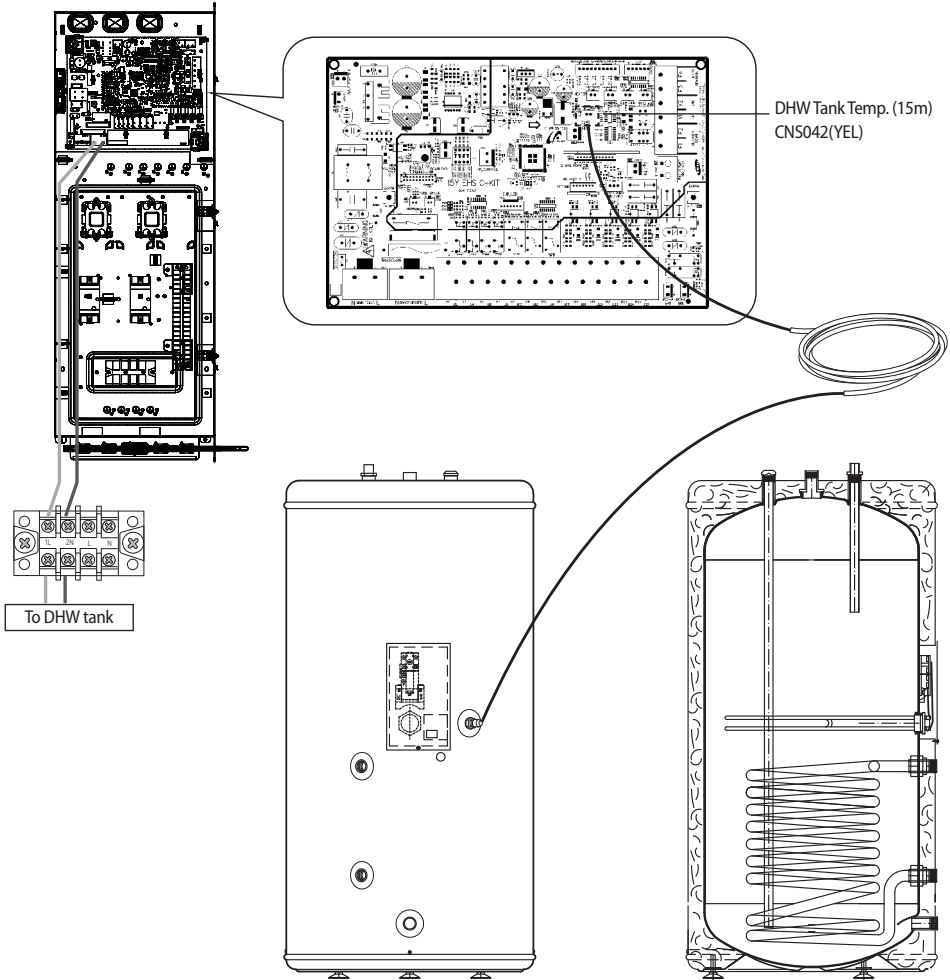

- * Use a correct sensor pocket which is fit for the DHW tank sensor(OD Ø6).
If the gap between the supplied sensor and DHW tank sensor pocket is big, use thermal grease.



- When you set the hot water supply temperature to 55°C or less, do not use the booster heater.
- The heatpump and the booster heater operate until the initial set temperature is reached. After that, only the booster heater may operate depending on the settings.

DHW tank

Electrical connections

Procedure



WARNING

- Switch off the power supply before making any connections.
- Use a thermal grease in thermistor pocket after installing electric connections.

Connections to be made in the electrical box of DHW tank

1. Connect the booster heater power supply and thermal protection cable.
2. Make sure to ensure strain relief of the cable.

Connections to be made in the electrical box of indoor units

3. Plug the thermistor cable connector in the connector CNS042 on the pcb.
4. Connect the booster heater power supply and thermal protection cable(field supply) to terminal TB-A1 and earth on the terminal block.
5. Connect the loose ends of the TB-A1 on the terminal block and the connector CNS042 on the PCB.
6. Plug the thermistor cable connector in the socket X9A on the PCB.
7. Connect the booster heater power supply and thermal protection cable (field supply) to terminal 7, 8, 21, 22 and earth on the terminal block.
8. Connect the booster heater power supply cable to the circuit breaker and earthing screw.
9. Fix the cables to the cable tie mountings with cable ties to ensure strain relief.



CAUTION

- Failing to fill the tank with water before energizing the electrical heater, will void the warranty.
- If the heater is installed, but not used, the tank must be flushed once per week.

Connection of the solar circulation pump for DHW tank

Description	No. of wires	Max. current	Thickness	Supply Scope
Solar pump / DHW Thermostat	2+ground	22mA	0.75mm ² H05RN-F or H07RN-F	Field supply (220-240V~, Input)

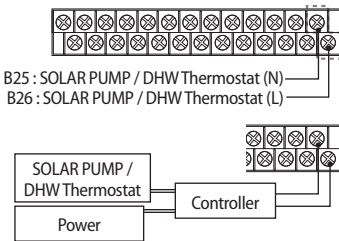

Solar pump operates when FSV 3061=1 is set, and DHW Thermostat operates when FSV 3061=2 is set.

1. Before connecting the external control kit, make sure it is turned off.
2. Using the appropriate equipment to correct position of terminal block as shown on the diagram.
3. The external control kit must provide an output signal when Solar pump/ DHW Thermostat is operating.
4. It is the installers responsibility to connect the output of the control kit to the Solar Pump/ DHW Thermostat input terminal (B25-26). In operating mode, signal shall be around 230VAC (N-L). In non-operating mode, signal shall be around 0VAC (N-L).

When solar pump signal is On, Hydro unit DHW mode will be turned off.



CAUTION

- Maximum allowable current of each terminal is below 10 mA.
- Ports number B25, B26 are for input port for detection and they do not supply power to a Solar pump / DHW Thermostat.

Troubleshooting

IMPORTANT: All maintenance or repair work must be executed by an approved installer.

Problem	Possible cause	Solution
Hot water is not coming out.	No power supply to the water heater	Check if there is any power on the power supply terminal on the thermostat.
	The thermostat may be set too high and cause the fuse or safety cut-off to operate.	Reduce thermostat setting by 5 °C and press the reset button.
Heating is not working	Heating element or internal electrical wiring is out of order.	Check if there is any power on the power supply on the connector of the heating element between black and yellow/green wires. If this is OK, press the reset button on the fuse/safety cut-off.
Water is not warm enough	Thermostat is set too low.	Adjust the thermostat up using a standard screwdriver.
	Heating element or the internal electrical wiring is partially out of order.	Check the resistance of the heating element on the connector of the heater bundle, and the condition of the internal wiring.
	UX mixing valve(fitted on top) is incorrectly adjusted.	Adjust the UX mixing valve correctly to the preferred temperature.
Safety valve(SV) is dripping.	Water expands when heated. If there is no consumption of hot water over a period of time pressure builds up, causing the safety valve to open.	If drip from the SV is severe, it might need to be replaced. Some dripping is normal. Alternatively an expansion vessel can be fitted.
Leak warning outlet is dripping.	The heating element may not be properly tightened.	Check the heating element o-ring seal and all connections.
	There may be a leak.	
Other problems, or if none of the above solves the problem.	-	Contact the installer/supplier regarding any other failure.



WARNING

Incorrect handling of thermostat, safety valve or other valves may lead to tank rupture. When servicing the unit follow instructions carefully:

- Always turn off main power supply when water supply is being shut off.
- Test the free operation of the safety valve regularly by opening the valve ensuring the water flows freely.
- Electrical connection and all servicing of the electrical components should only be carried out by an authorized electrician.
- Fitting and all servicing of plumbing fixtures should only be carried out by an authorized installer.
- When replacing the thermostat, safety valve or any other valve or part supplied with this unit, use only approved parts of the same specification.



CAUTION

- Before resetting the safety cut-off or altering the thermostat setting, always remember to isolate the electrical supply to the unit. This must be done prior to removing the electrical box lid.
- If the electric element or thermostat is defective, contact authorized electrician.
- After adjustments are completed, ensure the lid to the electrical box is refitted correctly and that the retaining screw is properly fitted.

Mixing Valve

Installation of mixing valve

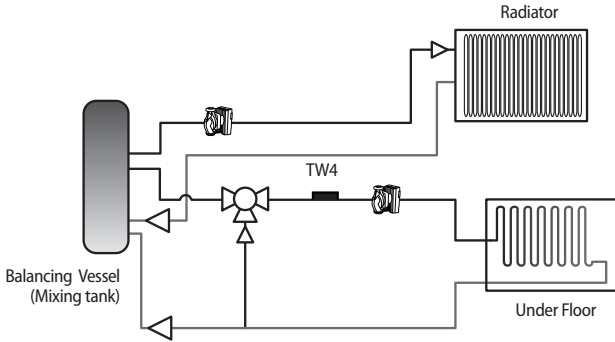

When two different zones are used with different temperatures, adjust the temperature of discharge water to high temperature water and control the amount of bypass to provide low temperature water by applying the mixing valve and temperature sensor of the mixing valve (TW4).

1. Select a mixing valve from the manufacturers as below (recommended) and install it at the entrance of the zone.
2. Install the supplied temperature sensor (TW4) on the rear part of the mixing valve. Install TW4 Sensor within 1m of Mixing Valve.
3. Since running time varies depending on the manufacturer, set the FSV (default 90 sec.) by referring to the FSV value below.

	Maker	BELIMO	SIEMENS	HONEYWELL
Model code	3 Way Valve	R3020-6P3-S2	VXP45.20-4 (kvs 4)	V5011E1213
	Actuator	LR230A(-S)	SSB31	ML6420A3015
Running time		90 sec.	150 sec.	60 sec.
FSV(#4046) setting		9	15	6

* The table above is for your reference. It can be changed without advanced notice.

4. Set the FSV value by referring to the table below depending on installation environment.

Function	Details	Code	Unit	Default	Min.	Max.
Mixing valve	Use or not	4041	-	0(No)	0	2
	Target temperature difference (Heating) (TW3-TW4)	4042	°C	10	5	15
	Target temperature difference (Cooling) (TW4-TW3)	4043	°C	10	5	15
	Control factor	4044	-	2	1	5
	Interval of valve control	4045	Min.	2	1	30
	Running time (10 second unit)	4046	(x10) sec	9	6	24

* 4041 = 1 : Controlled based on the temperature difference (4042, 4043)

* 4041 = 2 : Controlled based on the temperature difference of the WL value

ex)
Heating

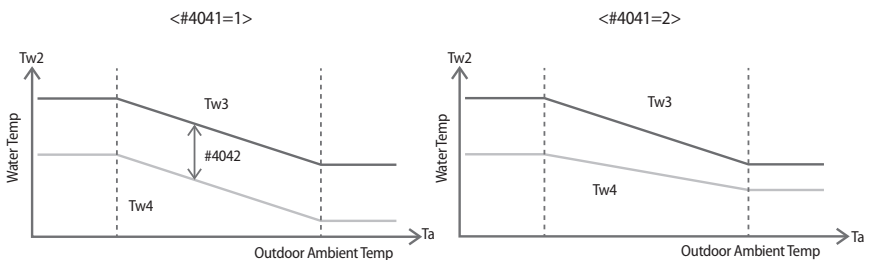

- * The mixing valve is controlled based on the FCU WL value.
- * As the #4044 value increases and the #4045 value decreases, the control speed increases. (Temperature hunting may occur if the control speed increases depending on the load.)
- * The additional pump and mixing valve should be purchased separately. TW4 sensor is included in the product accessories.
- * TW3 : Water temp. sensor 3



- When the thermostat control is set as 'Use', the mixing valve can be used for Zone 1 and Zone 2. (When both FSV #2091 and #2092 are set as 1/2)
- When using Zone control (FSV 4061 = 1), ignore Thermostat signal.

2-zone control using Thermostat

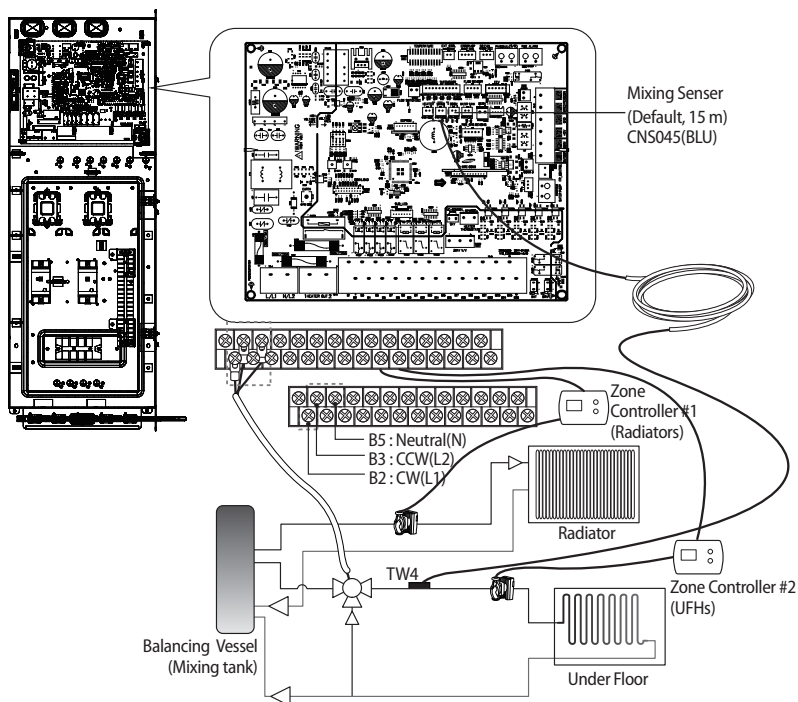

Description	No. of wires	Max. current	Thickness	Supply Scope
Mixing valve	4	22 mA	> 0.75 mm ² , H05RN-F or H07RH-F	Field supply (230 V~, Input)

1. Before the installation, hydro unit should be turned off.
2. Using the appropriate equipment to correct position on the terminal block as shown on the diagram.

Mixing Valve

2-Zone Control Using Remote Controller

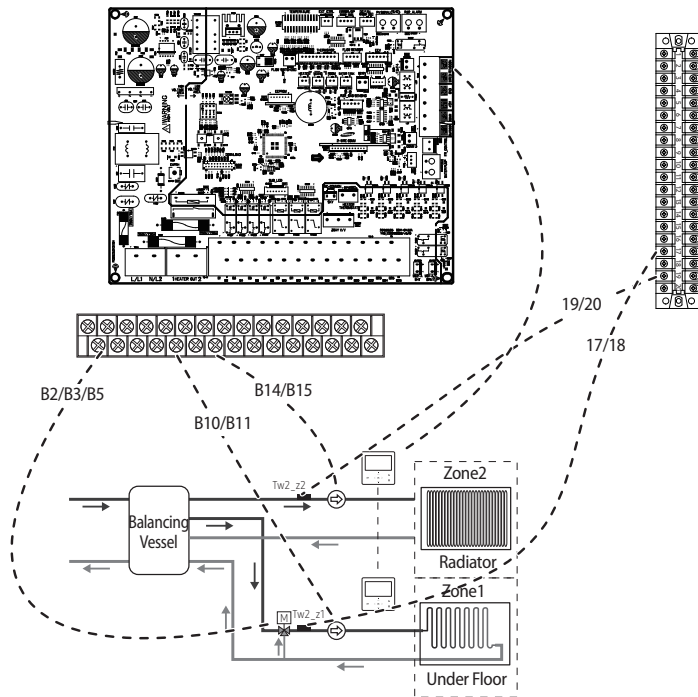

You can operate the 2-zone control using a mixing value, water-out temperature sensors, and built-in or external room temperature sensors installed in a wired remote controller.

When both zones are simultaneously Thermo on, the operation is performed based on Zone2. Therefore, set the zone that you want to have the higher set temperature to Zone2.

(The mixing valve must be installed in the zone that you want to have the lower set temperature.)

1. Install the mixing valve. (See "Installation of mixing valve.")
2. Install the water-out temperature sensors (Tw2_z1, Tw2_z2) for all zones.
3. Unlike the zone control with a thermostat, connect the water pump signal lines to the product.
 - ▶ Zone1 water pump connection: B10 (L1) + B11 (N)
 - ▶ Zone2 water pump connection: B14 (L1) + B15 (N)
4. FSV 4061 = 1: Enable the 2-zone control using the wired remote controller.

* If you want to operate the 2-zone control by using water-out temperatures, you have only to complete steps 1 to 4 above.

* If you want to operate the 2-zone control by using room temperatures and built-in temperature sensors in wired remote controllers, you must install two wired remote controllers in each room.

(If you use external room temperature sensors, you can control each room temperature with only one wired remote controller.)

Temperature sensor work

Example of sensor installation

Weld the sensor holder on the selected location of the pipe and then insulate it.

When the pipe is a copper pipe

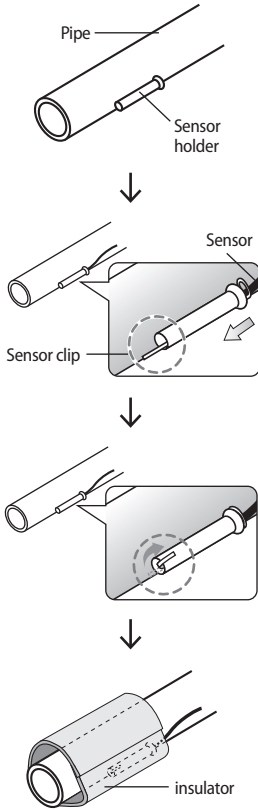

When the pipe is not a copper pipe

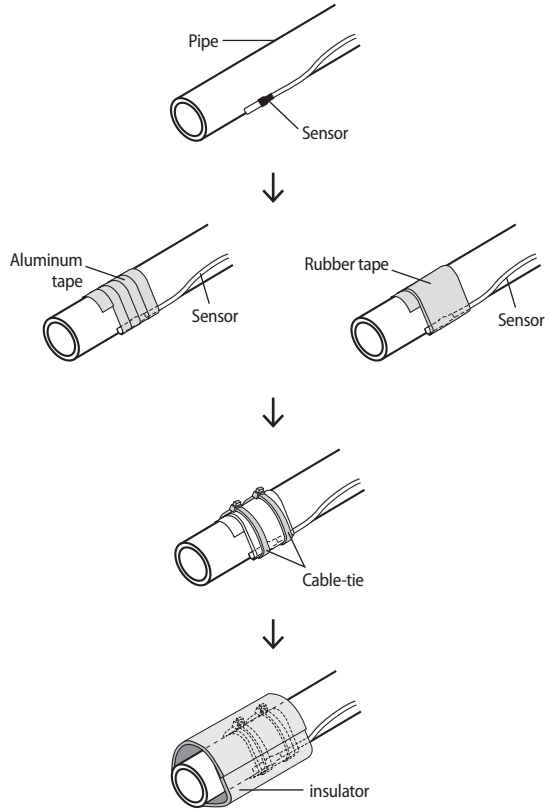

- When the Sensor holder cannot be welded on the pipe, fix the sensor with aluminum tape and insulate it.

Temperature sensor work

How to download to a microSD card

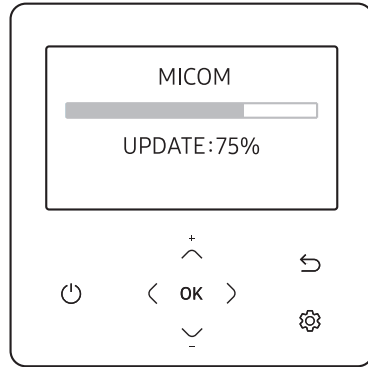
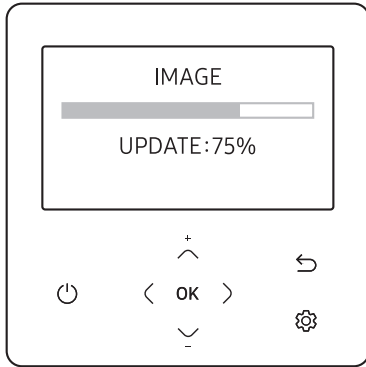

1. Download the wired remote controller image, change the file name to "IMAGE.BIN," and then download to microSD Card.
2. Download the wired remote controller program, change the file name to "MICOM.BIN," and then download to microSD Card.
3. Insert the microSD Card with the Wired Remote Controller active, and then reset the system.
For system reset, press the < and ⚙️ buttons at the same time for more than 5 seconds.
4. The download to microSD Card is performed as follows:
 - ▶ Download proceeds in the order of IMAGE and MICOM.
 - ▶ When the update fails, the Wired Remote Controller is reset automatically and the update proceeds again.
5. When the download is finished, tracking starts automatically.
When tracking is completed, remove the microSD Card.



- Be sure to use the microSD Card after formatting in FAT16 or FAT32.
- The microSD Card supports the SD or SDHC with the capacity of 1 GB to 32 GB.
- The update is performed only when the file version in the microSD Card differs from the one of the Wired Remote Controller.
- When the screen is frozen for more than 3 minutes after completing the microSD card update by 100%, product inspection is required.
- Delete the files except for the ones for download. (Only IMAGE.BIN and MICOM.BIN are required.)

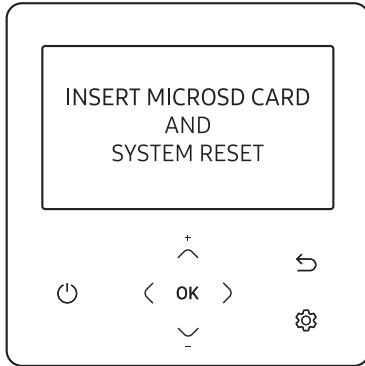

1. When you remove the microSD Card during download, the “INSERT MICROSD CARD AND SYSTEM RESET” screen appears and the download is stopped.
2. When you insert the microSD Card and press the < and  buttons for system reset, download starts again after finishing the reset.



NOTE

- When you reset the Wired Remote Controller while the microSD Card is removed, the above message appears on the screen in standby mode.
- When you reset the Wired Remote Controller while the microSD Card is removed and then inserted, the following actions are performed.
 - If the reinserted microSD Card contains all the files for update, update proceeds regardless of the version of the file.
 - If the reinserted microSD Card contains any missing files for update, the above message appears in standby mode.

Concrete curing function

When pipes of floor heating are installed, operation for reinforced concrete curing is applied. (Period of operation: 23 days)

Entering procedure

1. After turning off the DIP switch K3 of indoor unit (Default ON), power off and on the indoor unit. The operation for concrete curing starts automatically. (If blackout occurs and communication restarts later, operation will continue.)
2. Temperature of discharge water is controlled as time goes on like below.

Temp.

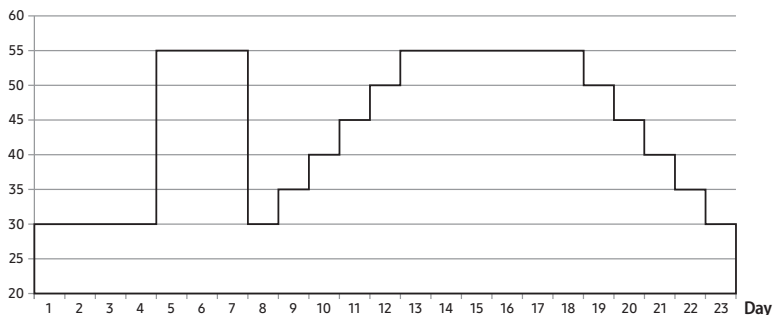

Classification	Initial Heating		Step raise				Heating	Step down				Total (Hour)		
	Time	Temperature	Time	Temperature	Time	Temperature		Time	Temperature	Time	Temperature			
Time	96	72	24	24	24	24	144	24	24	24	24	552		
Temperature	30	55	30	35	40	45	50	55	50	45	40	35	30	-

3. Remaining days are displayed on the wired remote controller during operation but key operation is unavailable.

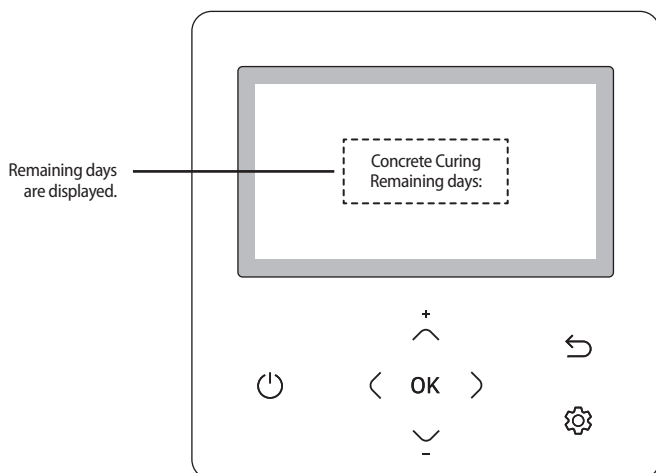

* If an error is displayed, concrete curing function does not work.

NOTE

- Definition of Dip switch function

Dip S/W	S/W #1	S/W #2	S/W #3	S/W #4
ON (default)	• None	• None	• None	• Turn off when an E101 error occurs
OFF	• Emergency heating	• Emergency hot water supply	• Concrete curing	• E101 error does not turn off
reference item	• Please refer to the user manual		• Please refer to the previous page	• Please refer to below

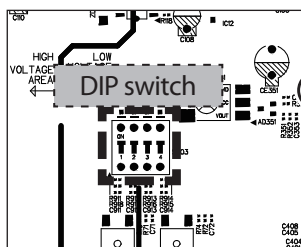

- When outdoor unit only power supply change by local condition, it is an option to auto restart system.

Classification		When the outdoor unit is power off	When the outdoor unit is power on
Hydro Unit operation according to the DIP S/W #4 setting	ON (default)	• Hydro Unit E101 error occurs.	• Hydro Unit E101 error disappears. • Hydro Unit operation turns off.
	OFF	• Hydro Unit E101 error occurs.	• Hydro Unit E101 error disappears. • Hydro Unit keeps its previous operation.

- The outdoor unit on/off control is not available with the A2A indoor unit.
- Although the outdoor unit is turned on after the E101 error occurred, the A2A indoor unit operation keeps turned off.

Installation option setting

- ▶ Set the indoor unit installation option with remote controller option.

The procedure of option setting

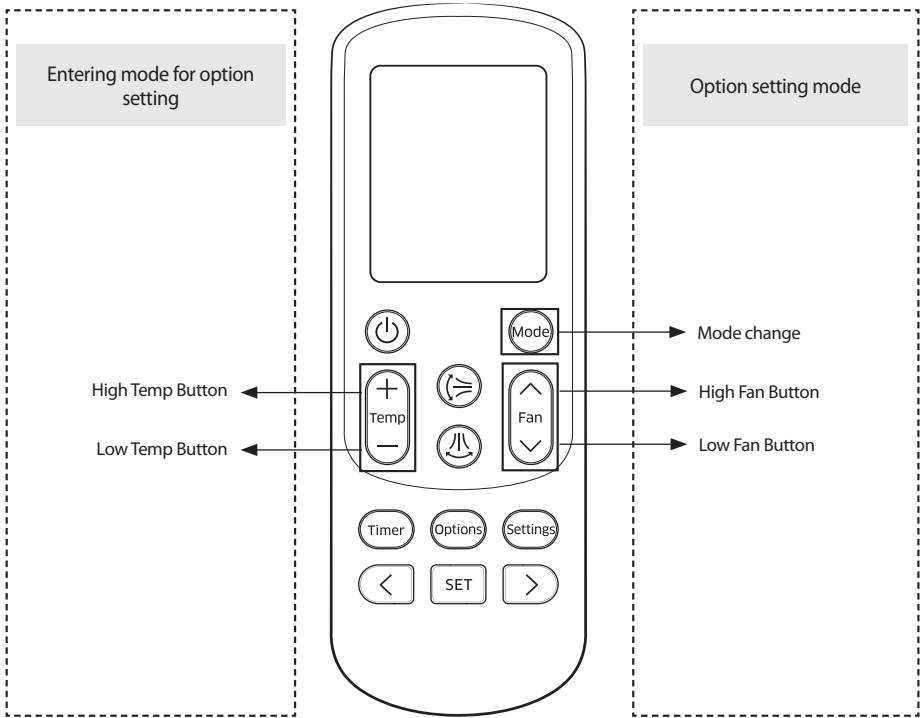





Entering mode to set option

1. Remove batteries from the remote controller.
2. Insert batteries and enter the option setting mode while pressing High Temp button and Low Temp button.
3. Check if you have entered the option setting status.

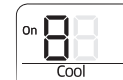

Changing a particular option

You can change each digit of set option.

Option	SEG1		SEG2		SEG3		SEG4		SEG5		SEG6	
Explanation	PAGE		MODE		The option mode you want to change		The tens' digit of an option SEG you will change		The unit digit of an option SEG you will change		The changed value	
Remote Controller Display												
Indication and Details	Indication	Details	Indication	Details	Indication	Details	Indication	Details	Indication	Details	Indication	Details
	0		D		Option mode	1~6	Tens' digit of SEG	0~9	Unit digit of SEG	0~9	The changed value	0~F

NOTE

- When changing a digit of an control kit address setting option, set the SEG3 as 'A'.
 - When changing a digit of control kit installation option, set the SEG3 as '2'.
- Ex) When setting the 'central controller' into disuse status.

Option	SEG1	SEG2	SEG3	SEG4	SEG5	SEG6
Explanation	PAGE	MODE	The option mode you want to change	The tens' digit of an option SEG you will change	The unit digit of an option SEG you will change	The changed value
Indication	0	D	2	0	5	0

* 02 Series installation option





Classification	SEG1~24
Use central controller (Default)	020010 100000 200000 300000
Disuse central controller	020000 100000 200000 300000

* 01 Series Productin Option(Factory default)

Model	SEG1~24
AE090RNYDEG/EU	012300 100000 200000 300000
AE090RNYDGG/EU	012300 110000 200000 300000

Optional : Extending the power cable

1. Prepare the following tools.

Tools	Spec	Shape
Crimping pliers	MH-14	
Connection sleeve (mm)	20xØ6.5 (HxOD)	
Insulation tape	Width 19 mm	
Contraction tube (mm)	70xØ8.0 (LxOD)	

2. As shown in the figure, peel off the shields from the rubber and wire of the power cable.

- Peel off 20 mm of cable shields from the pre-installed tube.



- For information about the power cable specifications for indoor and outdoor units, refer to the installation manual.
- After peeling off cable wires from the pre-installed tube, insert a contraction tube.
- If cable wires are connected without using connecting sleeves, their contact area becomes reduced, or corrosion develops on the outer surfaces of the wires (copper wires) over a long time. This may cause an increase of resistance (reduction of passing current) and consequently may result in a fire.

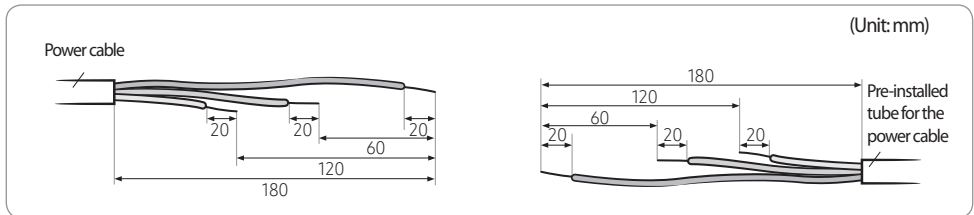

3. Insert both sides of core wire of the power cable into the connection sleeve.

- Method 1: Push the core wire into the sleeve from both sides.
- Method 2: Twist the wire cores together and push it into the sleeve.

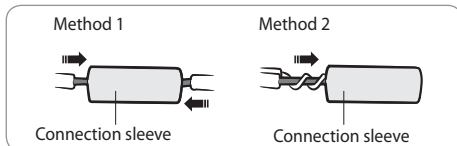

4. Using a crimping tool, compress the two points and flip it over and compress another two points in the same location.

- The compression dimension should be 8.0.

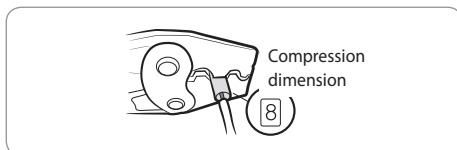

- After compressing it, pull both sides of the wire to make sure it is firmly pressed.

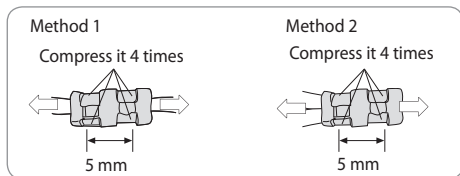

5. Apply heat to the contraction tube to contract it.

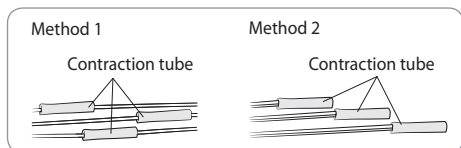

6. Wrap it with the insulation tape twice or more and position your contraction tube in the middle of the insulation tape.

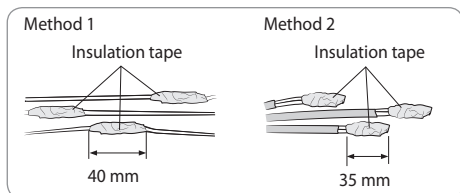

7. After tube contraction work is completed, wrap it with the insulation tape to finish.
Three or more layers of insulation are required.

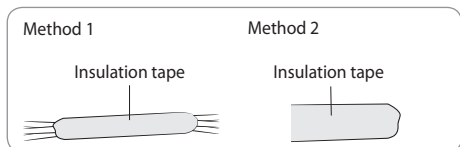

CAUTION

- Make sure that the connection parts are not exposed to outside.
- Be sure to use insulation tape and a contraction tube made of approved reinforced insulating materials that have the same level of withstand voltage with the power cable. (Comply with the local regulations on extensions.)



WARNING

- In case of extending the electric wire, please DO NOT use a round-shaped Pressing socket.
 - Incomplete wire connections can cause electric shock or a fire.

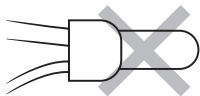

Reference (KEYMARK Certification)

Model code Outdoor	Model code Indoor	Registration number
AE040RXEDEG/EU	AE200RNWSEG/EU	011-1W0451
AE060RXEDEG/EU	AE200RNWSEG/EU	
AE040RXEDEG/EU	AE090RNYDEG/EU	011-1W0453
AE060RXEDEG/EU	AE090RNYDEG/EU	
AE040RXEDEG/EU	AE260RNWSEG/EU	011-1W0452
AE060RXEDEG/EU	AE260RNWSEG/EU	
AE090RXEDEG/EU	AE200RNWSEG/EU	011-1W0454
AE090RXEDEG/EU	AE090RNYDEG/EU	011-1W0456
AE090RXEDGG/EU	AE090RNYDGG/EU	
AE090RXEDEG/EU	AE260RNWSEG/EU	011-1W0455
AE090RXEDGG/EU	AE260RNWSGG/EU	

Memo



This appliance is filled with R-32.