

# Wellis®

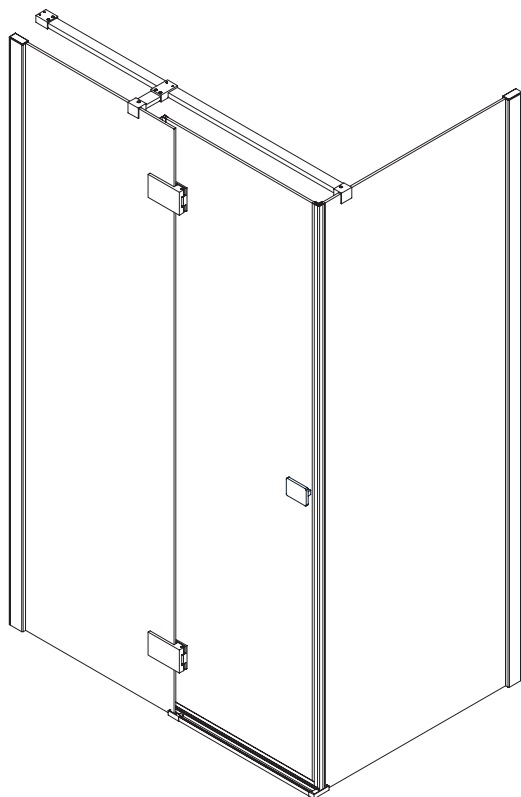

EN

**Clyde steam cabin**  
INSTALLATION INSTRUCTIONS

DE

**Clyde Dushkabine**  
AUFBAUANLEITUNG

FR

**Cabin de douche Clyde**  
GUIDE d'INSTALLATION

HU

**Clyde zuhanykabin**  
TELEPÍTÉSI ÚTMUTATÓ

WC00338  
WC00339

**CLYDE**

## ■ General Information

Please inspect the product immediately upon receipt for transit damage, missing packs/parts or manufacturing fault. Damage reported later cannot be accepted. Please handle the product with care avoiding knocks and shock loading to all sides and edges of the glass.

Note: Safety glass can not be re-worked.

## ■ Installation

Please read these instructions carefully before start of installation.

The wall post has up to 20mm of adjustment for out of true wall situations.

**Ensure that the shower tray is fitted level and that after assembly of enclosure there is a full and continuous bead of sealant between the top of the shower tray and the tile joint.**

Special care should be taken when drilling walls to avoid hidden pipes or electrical cables.

Note: This product is heavy and will require two people to install.

Please remove protective film from aluminium profiles before installation.

## ■ Shower Tray Installation

The shower tray must be sited against a structural wall.

Water proof walling or tiling should be fitted so that it sits on the top of the tray rim.

## ■ Aftercare Instructions

After use, your shower should be cleaned with soap and water. This is particularly important in hard water districts where insoluble lime salts may be deposited and allowed to build up. Cleaners of a gritty or abrasive nature should not be used. Care should be taken to avoid contact with strong chemicals such as organic solvents and strippers.

Glass cleaners can be used but with caution, if in doubt contact the supplier of the cleaner in question.

Please keep these instructions for aftercare and customer service details.

## Tools required

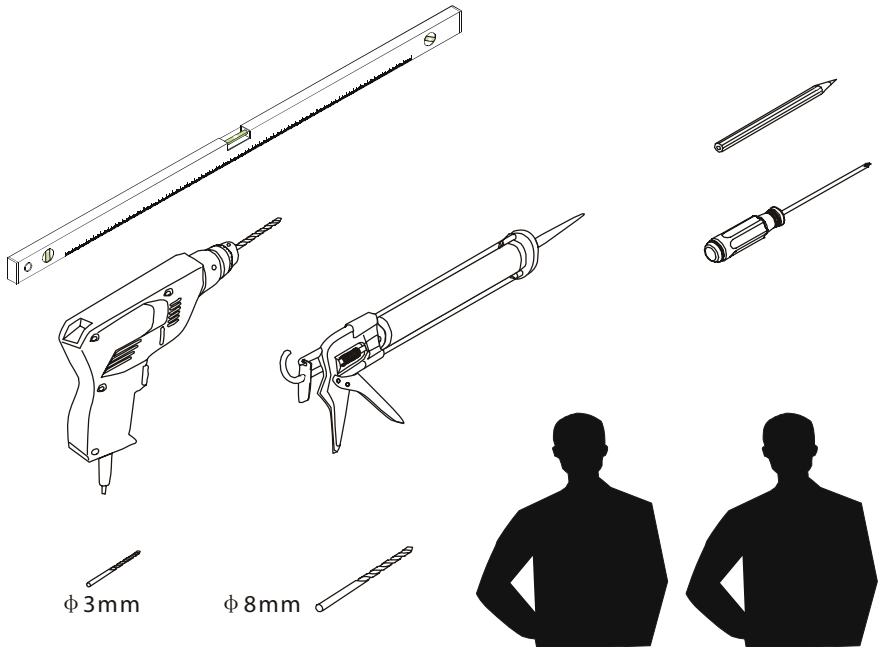

This product is heavy and will require two people to install.



## ■ Allgemeine Hinweise

Bitte überprüfen Sie das Produkt direkt nach dem Empfang auf Lieferschäden, fehlende Pakete/Teile oder Herstellerfehler. Nachträgliche Reklamation kann nicht akzeptiert werden. Bitte behandeln Sie das Produkt pfleglich und vermeiden Sie hartes Aufstoßen oder Absetzen an allen Seiten sowie Glasecken.

**Hinweis: Sicherheitsglas kann nicht ersetzt werden.**

## ■ Aufbau

Lesen Sie vor dem Aufbau die Bedienungsanleitung sorgfältig.

Der Wandposten kann um bis zu 20mm verstellt werden, um die Deckenhöhe passend anzupassen.

**Stellen Sie sicher, dass die Duschwanne waagrecht montiert ist und dass nach der Montage des Gehäuses zwischen dem oberen Ende der Duschwanne und dem Kachelanschluss ein durchgehender Dichtungswulst vorhanden ist**

Besonders vorsichtig sollten Sie beim Bohren an Wänden vorgehen, um keine dahinterliegenden Stromleitungen oder Rohrleitungen zu beschädigen.

Hinweis: Dieses Produkt ist schwer und zum Aufbau werden zwei Personen benötigt.

Bitte entfernen Sie vor dem Aufbau die Sicherheitsfolie von allen Aluminiumgegenständen.

## ■ Aufbau der Duschwand

Die Duschwand muss beim Aufbau aufrecht gegen die Wand gelehnt werden.

Oberhalb des Wandbereichs sollten Sie wasserabweisende Fliesen oder Wandfolie befestigen.

## ■ Pflegehinweise

Reinigen Sie die Dusche nach der Nutzung mit Wasser und Seife. Besonders in Gegenden mit hoher Wasserhärte ist dies wichtig, damit sich keine Kalkrückstände bilden können. Scharfe Reiniger oder chemikalische Reinigungsmittel sollten Sie vermeiden. Vermeiden Sie den Kontakt mit chemikalischen Reinigungsmitteln oder Beizmitteln.

Glasreiniger kann unter Vorsicht verwendet werden. Bei Zweifeln oder Fragen bezüglich der Inhaltsstoffe wenden Sie sich bitte an den Hersteller des Reinigers.

Bewahren Sie diese Unterlagen für die Nachsorge und Informationen zum Kundenservice.

## BENÖTIGTE WERKZEUGE

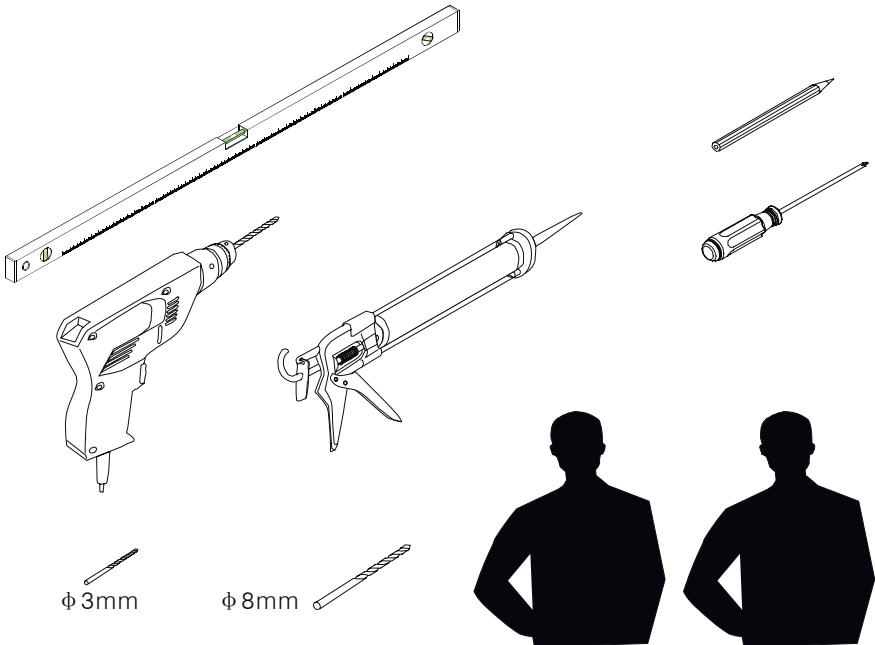

φ 3mm

φ 8mm



Dieses Produkt ist schwer und zum Aufbau werden zwei Personen benötigt.



## Informations Générales

Veillez inspecter immédiatement le produit après l'avoir reçu et vérifier qu'il n'a pas été abîmé pendant le transport, qu'il ne manque pas de pièces ou qu'il n'y a pas de défauts de fabrication. Tout défaut signalé ultérieurement ne pourra être pris en compte. Veillez à manipuler le produit avec soin en évitant les chocs sur toutes les faces des vitres.

**Note : Les vitres de sécurité ne peuvent pas être re-travaillées.**

## Installation

Veillez lire ces instructions attentivement avant de commencer l'installation.

La paroi murale est extensible de 20mm de chaque côté.

**Veillez vous assurer que le bac de douche est mis à niveau et que le joint d'étanchéité est correctement posé entre le bac de douche et le carrelage.**

Une attention particulière doit être portée lorsque vous percez les murs afin de ne pas endommager le tuyau ou de câble électrique.

Note : Ce produit est lourd, 2 personnes sont nécessaires à son installation.

## Installation du Bac de Douche

Le bac de douche doit être fixé contre un mur porteur.

Un carrelage étanche doit être adapté afin qu'il se trouve au-dessus du rebord du bac de douche.

## Entretien

Après utilisation, votre douche doit être nettoyée avec du savon et de l'eau. Ceci est particulièrement important dans les régions où l'eau est dure, le calcaire pouvant se déposer et s'accumuler. Ne pas nettoyer avec une éponge abrasive ou granuleuse. Évitez tout contact avec des produits chimiques tels que les solvants organiques et les décapants. Les nettoyants pour vitres doivent être utilisés avec attention. En cas de doute, veuillez contacter le distributeur du produit en question.

Veillez conserver les instructions pour l'entretien et le service après-vente.

## Outils à utiliser

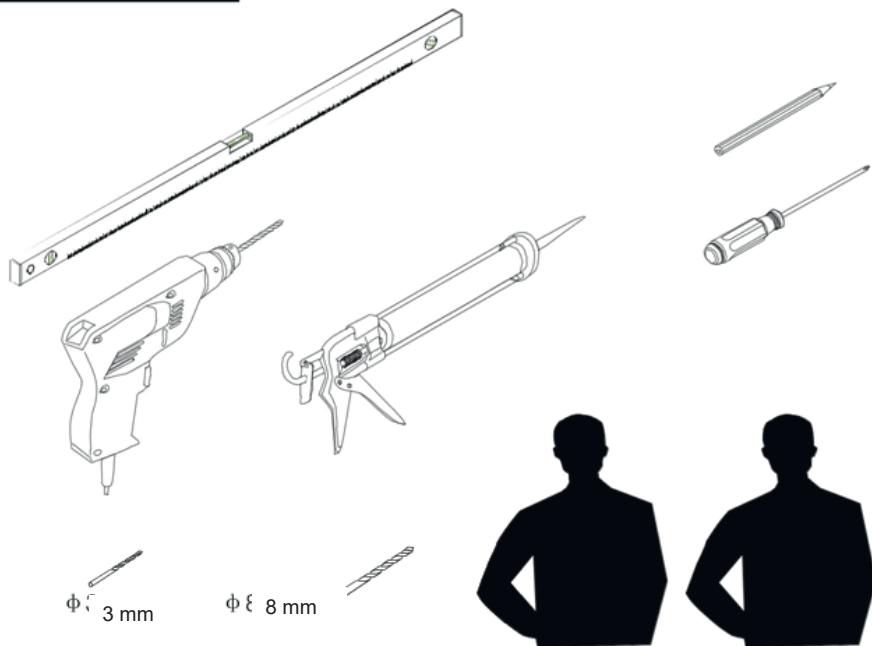

Ce produit est lourd. 2 personnes sont nécessaires à son installation.



## ■ Általános információ

Kérjük az átvételkor azonnal vizsgálja meg a terméket és ellenőrizze, hogy az nem sérült-e meg szállításkor, nem hiányzik-e belőle csomag/alkatrész, nincs-e benne gyártási hiba. A később jelentett hibákat nem fogadjuk el. Kérjük óvatosan bánjon a termékkel és kerülje az üveg oldalait és széleit erő sérüléseket.

**Megjegyzés: A biztonsági üveget nem lehet újradolgozni.**

## ■ Telepítés

Kérjük a beszerelés megkezdése előtt figyelmesen olvassa el az útmutatót.  
A falhoz illeszthető oszlop 20mm-re állítható a tényleges fal helyzete alapján.

Biztosítsa, hogy a zuhanytálca vízszintesen van beállítva, és hogy a burkolat összeszerelése után a tömítés a zuhanytálca és a csempe fuga között teljes és szakadatlan.

Fúráskor különösen figyeljen a fal mögötti csövekre és elektromos kábelekre.

Megjegyzés: Ez a termék nehéz és két ember szükséges a beszereléséhez.

Beszerelés előtt kérjük távolítsa el a védőfóliát az alumínium alkatrészekről.

## ■ Zuhanytálca beszerelés

A zuhanytálcát tartófalhoz kell illeszteni.

Vízálló falazatot vagy csempét kell telepíteni, úgy, hogy az a tálca szélének tetejéig érjen.

## ■ Karbantartási útmutató

Használat után a zuhanyt tisztítsa ki szappannal és vízzel. Ez különösen fontos olyan térségekben, ahol magas a vízkeménység és oldhatatlan mész rakódhat le és halmozódhat fel. Ne használjon szemcsés tisztítószeret vagy csiszolószereket. Kerülje az olyan erős vegyszerekkel való érintkezést, mint a szerves oldószerek és a lemarató szerek. Legyen óvatos az üvegtisztítók használatával. Amennyiben bármi kétsége van, lépjen kapcsolatba az adott tisztítószer gyártójával. Kérjük tartsa meg a karbantartással és a vevőszolgálattal kapcsolatos információkat.

## Szükséges eszközök

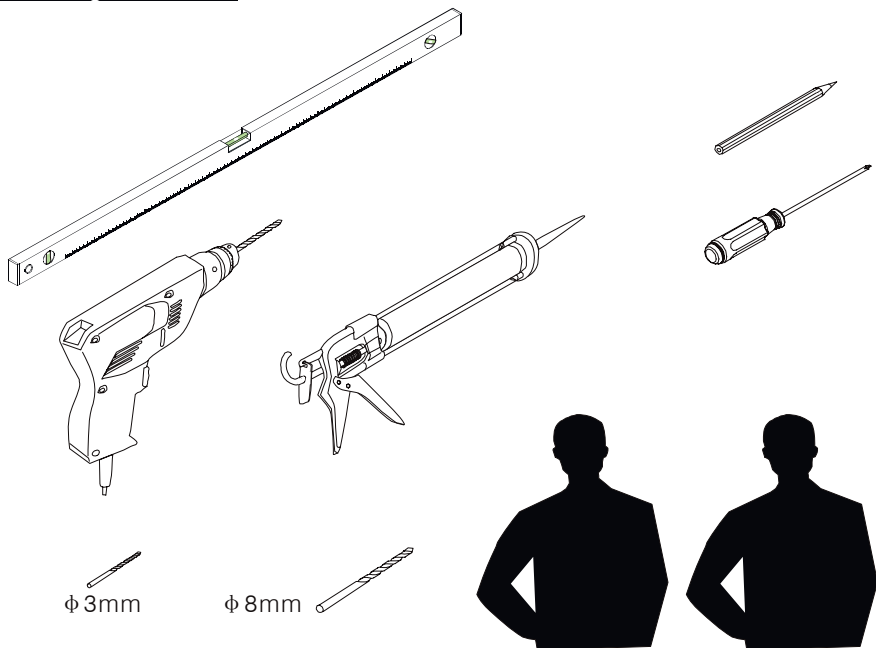

Ez a termék nehéz és két ember szükséges a beszereléséhez.



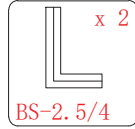
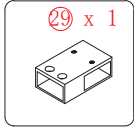
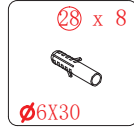
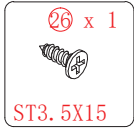
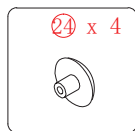
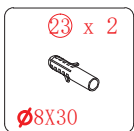
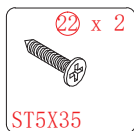
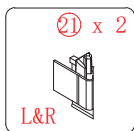
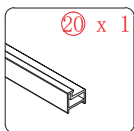
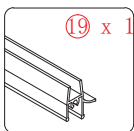
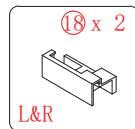
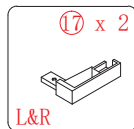
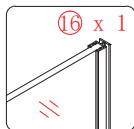
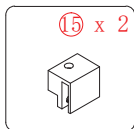
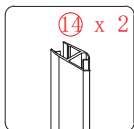
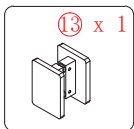
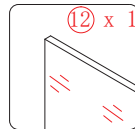
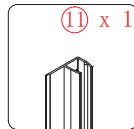
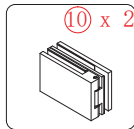
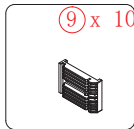
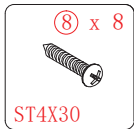
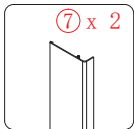
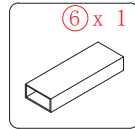
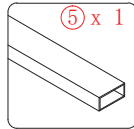
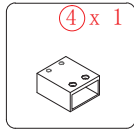
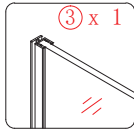
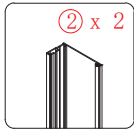
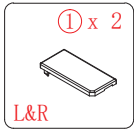
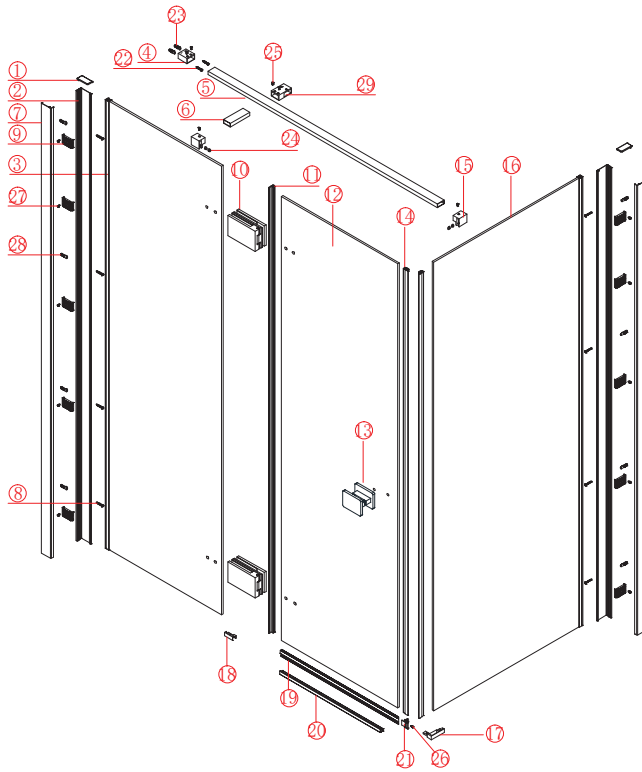

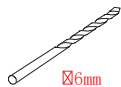
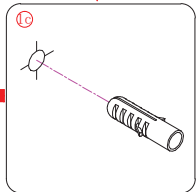
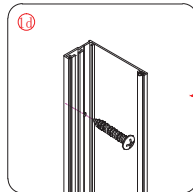
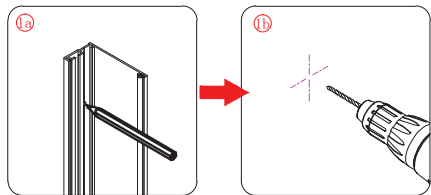
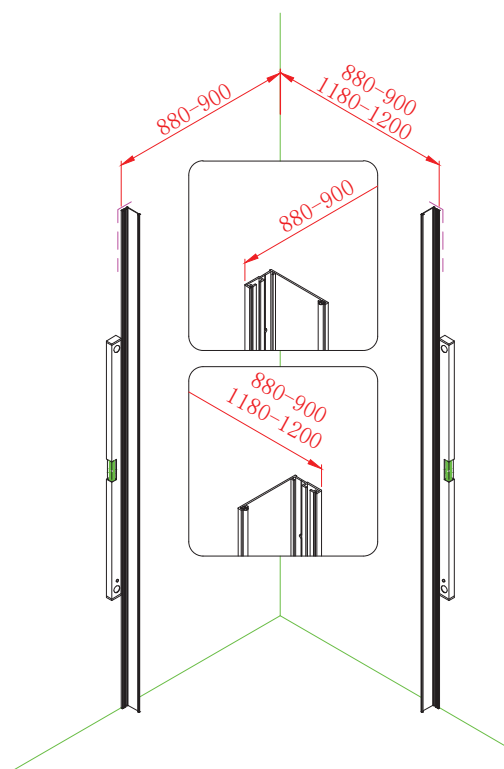

× 8

× 8

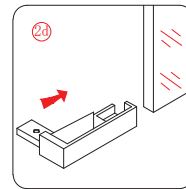
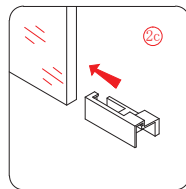
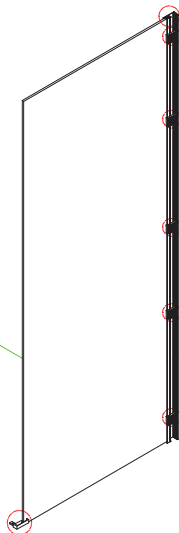
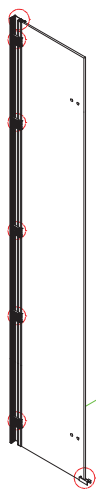
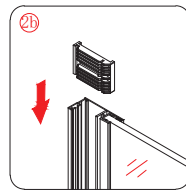
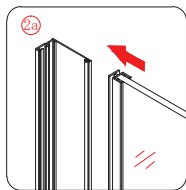

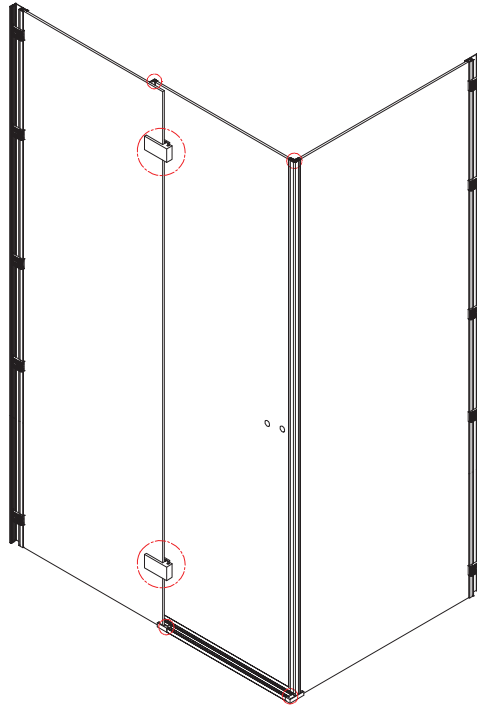
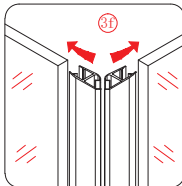
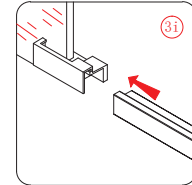
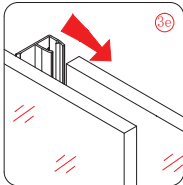
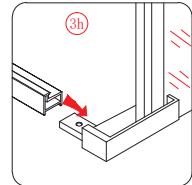
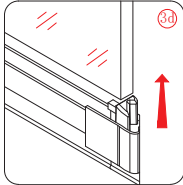
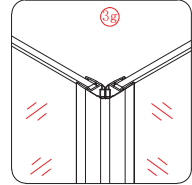
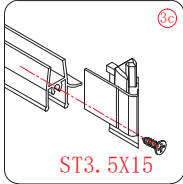
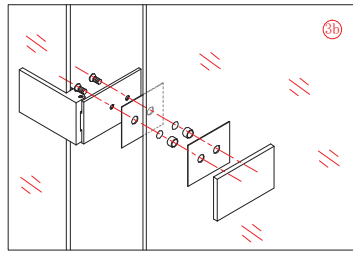
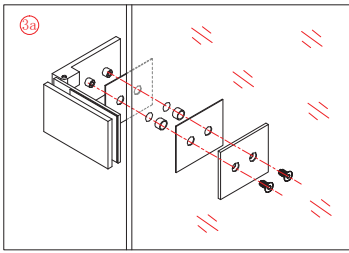



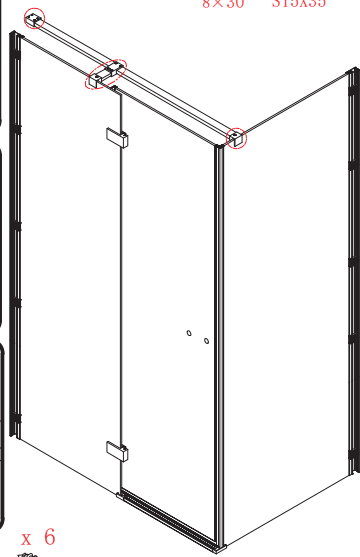
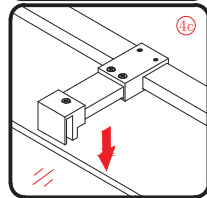
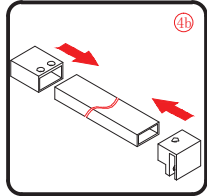
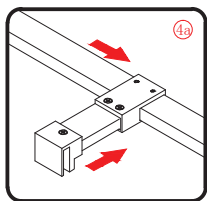

× 2  
8×30  
× 2  
ST5X35

x 6  
ST4X12

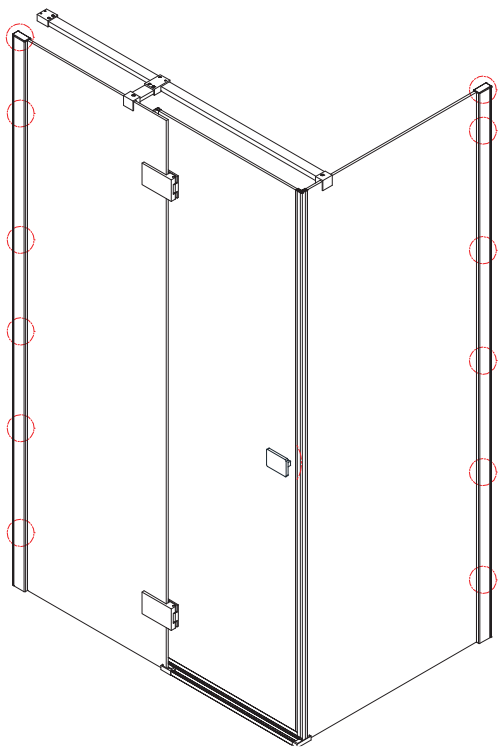
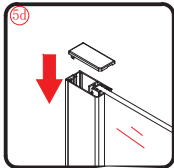
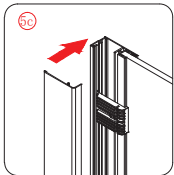
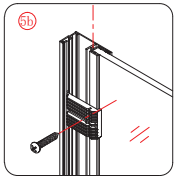
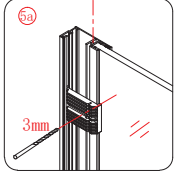
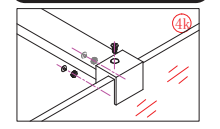
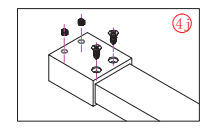
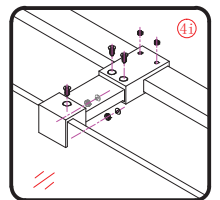
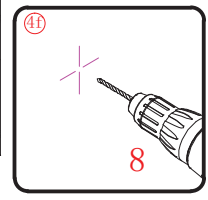
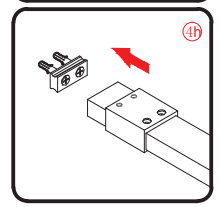
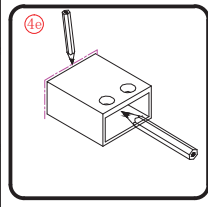
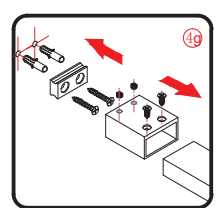
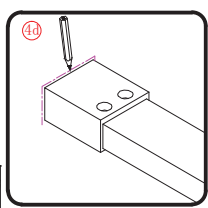

X10  
ST4X15

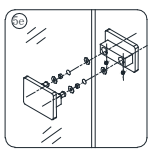

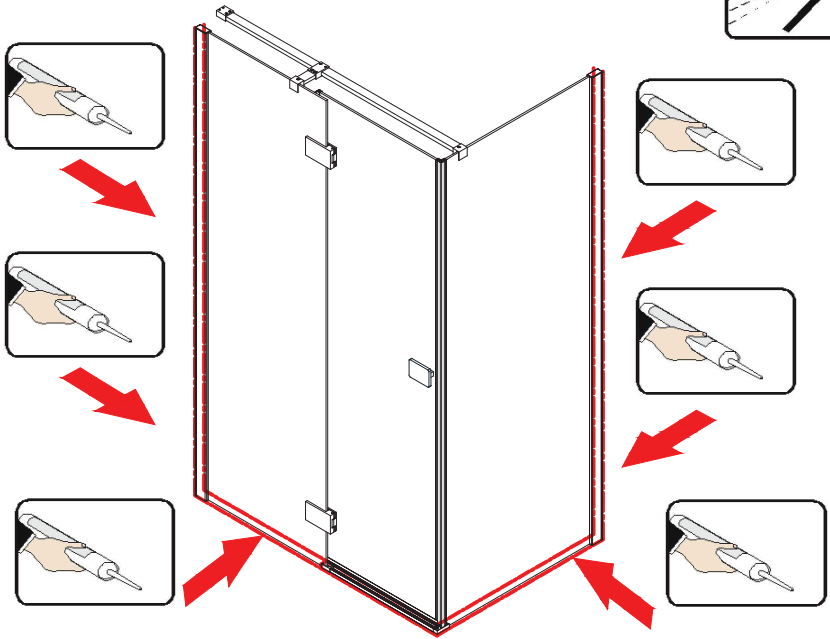

**24 hour**

The icon shows a hand holding a spray nozzle, with a diagonal line crossing it out. This indicates that spraying is not permitted. The text "24 hour" is positioned above the icon.

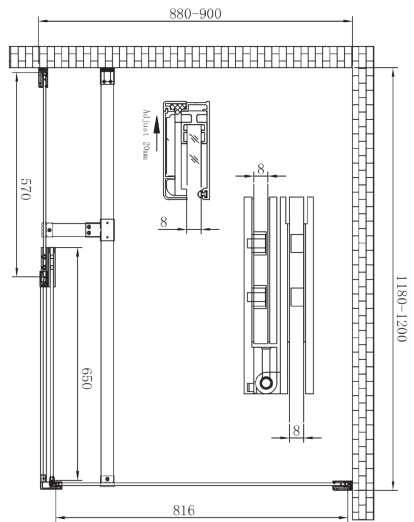
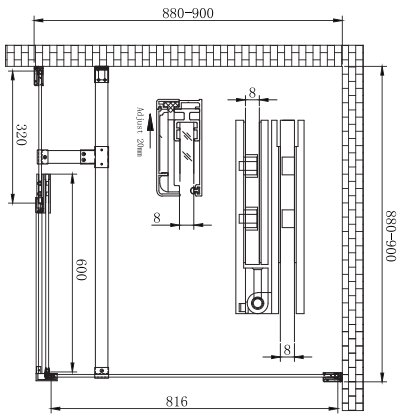
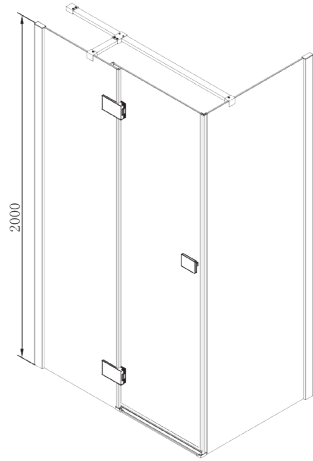
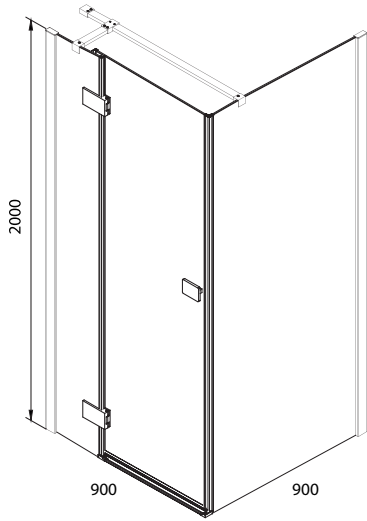

Wellis®

CE