

# N1 DUAL WHITE

PNEUMATIC VALVE

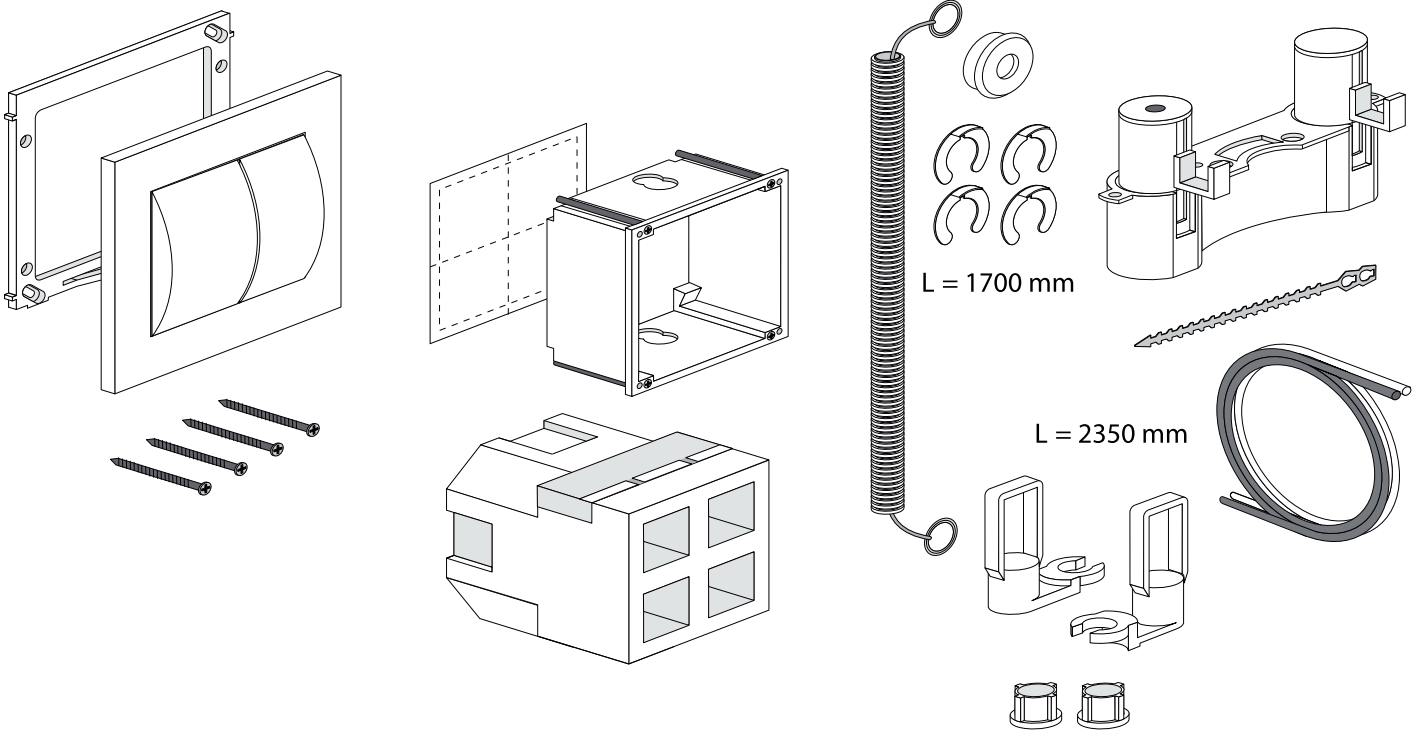

PM-308-73--0000-1/15

