

Alkatrész- katalógus 2015-2016

**KNOW
HOW**
INSTALLED

Tartalom

| | | |
|----------|--|-----------|
| 1 | Alkatrész áttekintő | 4 |
| 1.1 | Szervizkoffer falsík alatti öblítőtartályhoz | 4 |
| 1.2 | Szervizkoffer falsík alatti öblítőtartályhoz | 6 |
| 1.3 | Falsík alatti öblítőtartály | 8 |
| 1.4 | Nyomólapok | 16 |
| 1.5 | Falon kívüli öblítőtartály | 22 |
| 1.6 | Vizelde vezérlések | 24 |
| 1.7 | Kiegészítők | 36 |
| 2 | Cikkszámjegyzék | 40 |

1 Alkatrészkatalógus

1.1 Szervizkoffer

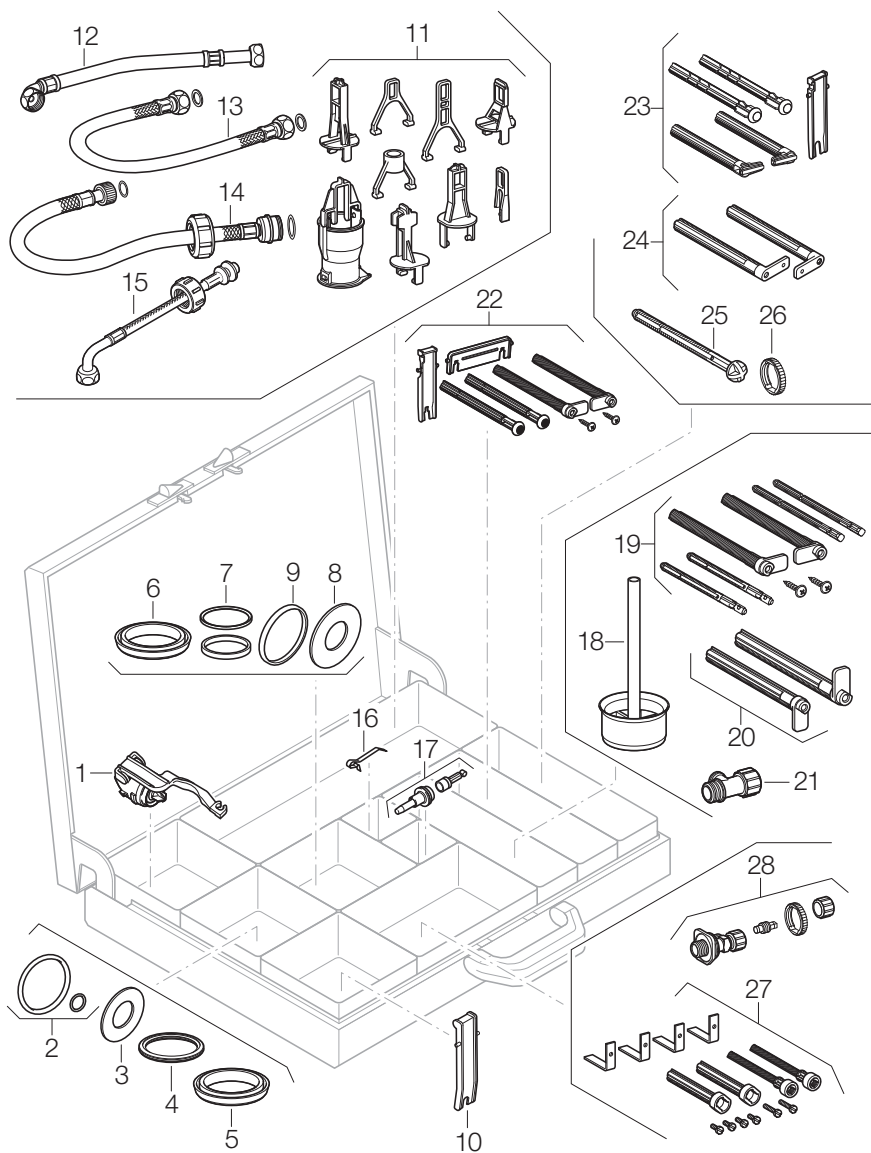

| Poz. | Termékmegnevezés | |
|------|--|--------------|
| | Geberit szervizkoffer falsík alatti öblítőtartályokhoz | 242.805.00.1 |
| 1 | Impuls380 (Unifill) töltőszelep javítószett | 240.771.00.1 |
| 2 | O-gyűrű szett flexibilis bekötőcsőhöz (2002-től gyártottakhoz) | 240.922.00.1 |
| 3 | Öblítőszelep tömítés d63x32 | 816.418.00.1 |
| 4 | Ajacos gumitömítés öblítőív tokhoz, d45 öblítőcsőhöz | 362.771.00.1 |
| 5 | Szelepkosár tömítőgyűrű (2007-ig) | 240.282.00.1 |
| 6 | Szelepkosár tömítőgyűrű (2008-tól) | 241.868.00.1 |
| 7 | Öblítőcső tömítéskészlet EPDM/PP, d50 | 258.236.00.1 |
| 8 | Öblítőszelep tömítés d63x32, a 1 10.000/500/600-hoz, 1974-ig gyártottakhoz | 891.015.00.1 |
| 9 | Tömítőgyűrű kosárhoz | 894.082.00.1 |
| 10 | Megszakító kar Highline nyomólaphoz | 240.066.00.1 |
| 11 | Öblítőszelep kengyelek | 241.167.00.1 |
| 12 | Flexibilis bekötőcső UP-Artline tartályhoz (fentről/előlről működtethető nyomólaphoz, öblítőtartály építési magasság 82/90 cm) | 240.329.00.1 |
| 13 | Flexibilis bekötőcső UP-tartályhoz, 1998-ig gyártottakhoz, 2 x R3/8" BM csatlakozóval | 240.069.00.1 |
| 14 | Flexibilis bekötőcső UP-tartályhoz 2002-től gyártottakhoz | 240.921.00.1 |
| 15 | Flexibilis bekötőcső fentről működtethető tartályhoz | 240.321.00.1 |
| 16 | Rugó nyomólaphoz | 813.514.00.1 |
| 17 | Tömítőkészlet kompakt töltőszelephez | 240.182.00.1 |
| 18 | Torlóbetét öblítőszelephez | 240.476.00.1 |
| 19 | Nyomólap rúdkészlet UP200-as öblítőtartályhoz (Kappa, Artline) | 240.639.00.1 |
| 20 | Távolságtartó rúd nyomólap rögzítőkeretéhez (UP300/200/100 és Artline öblítőtartályhoz (2db)) | 240.173.00.1 |
| 21 | Sarokszelep UP-tartályhoz | 216.599.00.1 |
| 22 | Nyomólap rúdkészlet UP300-hoz, 2008-ig gyártottakhoz | 241.875.00.1 |
| 23 | Nyomólap rúdkészlet UP320-hoz, 2008-tól gyártottakhoz | 241.874.00.1 |
| 24 | Távartó rúd UP-tartályhoz 1998-ig gyártottakhoz (2db.) | 240.067.00.1 |
| 25 | Nyomórúd UP-tartályhoz 1998-ig gyártottakhoz | 240.074.00.1 |
| 26 | Sarokszelep rögzítő gyűrű, műanyag | 241.857.00.1 |
| 27 | Hosszabbító készlet UP320/300/200-as tartályokhoz | 240.938.00.1 |
| 28 | Sarokszelep UP320/200 | 240.269.00.1 |



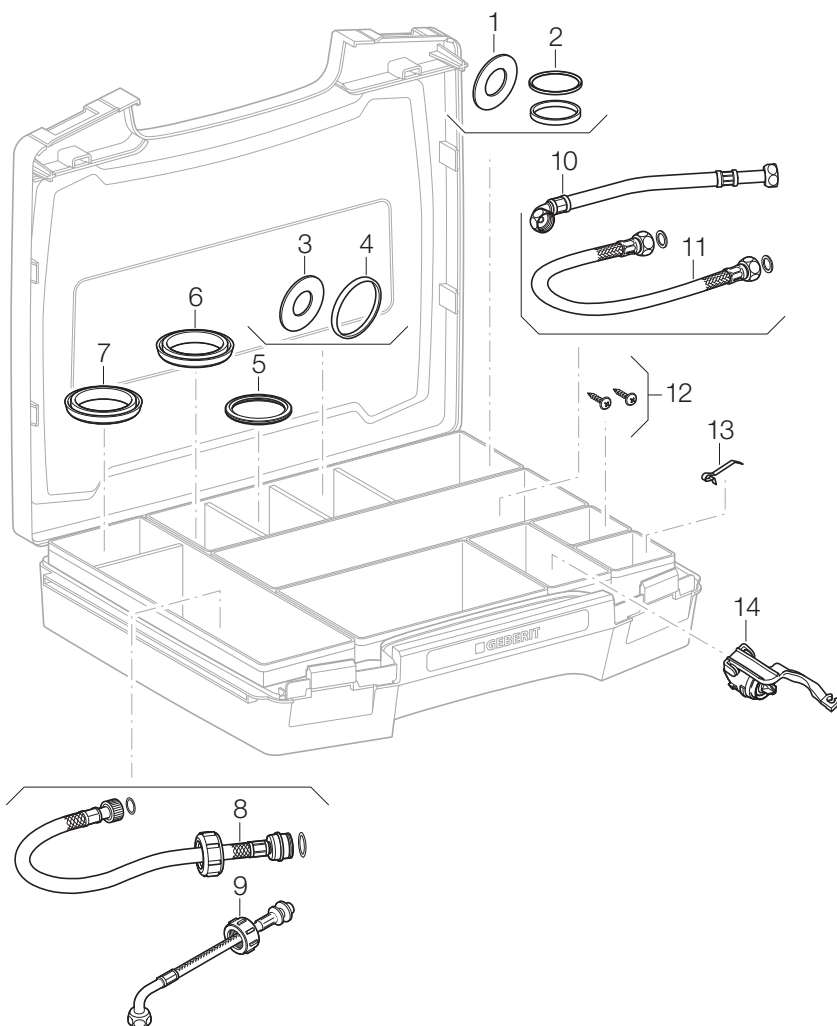

1.2 Szervizkoffer





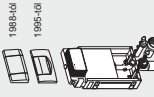

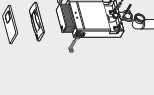







| Poz. | Termékmegnevezés | |
|------|--|--------------|
| | Geberit szervizkoffer falsík alatti öblítőtartályokhoz | 242.806.00.1 |
| 1 | Öblítőszelep tömítés d63x32 | 816.418.00.1 |
| 2 | Öblítőcső tömítéskészlet EPDM/PP, d50 | 258.236.00.1 |
| 3 | Öblítőszelep tömítés d63x32, a 110.000/500/600-hoz, 1974-ig gyártottakhoz | 891.015.00.1 |
| 4 | Tömítőgyűrű kosárhoz | 894.082.00.1 |
| 5 | Ajacos gumitömítés öblítőív tokhoz, d45 öblítőcsőhöz | 362.771.00.1 |
| 6 | Szelepkosár tömítőgyűrű (2007-ig) | 240.282.00.1 |
| 7 | Szelepkosár tömítőgyűrű (2008-tól) | 241.868.00.1 |
| 8 | Flexibilis bekötőcső UP-tartályhoz 2002-ig gyártottakhoz | 240.921.00.1 |
| 9 | Flexibilis bekötőcső fentről működtethető tartályhoz | 240.321.00.1 |
| 10 | Flexibilis bekötőcső UP-Artline tartályhoz (fentről/előlről működtethető nyomólapokhoz, öblítőtartály építési magasság 82/90 cm) | 240.329.00.1 |
| 11 | Flexibilis bekötőcső UP-tartályhoz, 1998-ig gyártottakhoz, 2 x R3/8" BM csatlakozóval | 240.069.00.1 |
| 12 | Csavar KA50x16-WN1411-A2, rozsdamentes | 905.994.00.0 |
| 13 | Rugó nyomólaphoz | 813.514.00.1 |
| 14 | Impuls380 (Unifill) töltőszelep tömítés készlet | 240.771.00.1 |

| | | | | | | |
|---|--------------|--------------|--------------|--------------|---|--------------|
|  | 240.771.00.1 | 240.771.00.1 | 240.771.00.1 | 240.771.00.1 | 240.771.00.1 | 240.771.00.1 |
| Impuls380 (Unifill) töltőszelep javító-készlet | - | - | - | - | Figyelem! A szelepkosár önmagában nem cserélhető ki az egyedi Geberit kialakítás miatt. | 240.771.00.1 |
|  | 240.187.00.1 | 240.187.00.1 | 240.187.00.1 | 240.187.00.1 | 240.187.00.1 | 240.187.00.1 |
| Öblítőszelep kosár (cserélhető) | - | 240.187.00.1 | 240.187.00.1 | 240.187.00.1 | 240.187.00.1 | 240.187.00.1 |
|  | 894.082.00.1 | 894.082.00.1 | 894.082.00.1 | 894.082.00.1 | 894.082.00.1 | - |
| Tömítőgyűrű kosárhoz | - | 894.082.00.1 | 894.082.00.1 | 894.082.00.1 | 894.082.00.1 | - |
|  | 241.170.00.1 | 241.170.00.1 | 241.170.00.1 | 241.170.00.1 | 241.170.00.1 | 241.170.00.1 |
| Rögzítő öblítőtartályhoz | 241.170.00.1 | 241.170.00.1 | 241.170.00.1 | 241.170.00.1 | 241.170.00.1 | 241.170.00.1 |
|  | 216.599.00.1 | 216.599.00.1 | 216.599.00.1 | 216.599.00.1 | 216.599.00.1 | 216.599.00.1 |
| Sarokszelep | - | 216.599.00.1 | 216.599.00.1 | 216.599.00.1 | 216.599.00.1 | 216.599.00.1 |
|  | 362.771.00.1 | 362.771.00.1 | 362.771.00.1 | 362.771.00.1 | 362.771.00.1 | 362.771.00.1 |
| Ajakos tömítés öblítőcsőhöz, d45 | 362.771.00.1 | 362.771.00.1 | 362.771.00.1 | 362.771.00.1 | 362.771.00.1 | 362.771.00.1 |
|  | - | - | - | - | 240.026.00.1 | 240.026.00.1 |
| Átlátszó védőlap, emelőszerkezettel, (előlről működtethető nyomólapozhoz) | - | - | - | - | 240.026.00.1 | 240.026.00.1 |
|  | - | - | - | - | 216.024.00.1 | 216.024.00.1 |
| Menetes szár | - | - | - | - | 216.024.00.1 | 216.024.00.1 |
|  | 115.222.xx.1 | 115.222.xx.1 | 115.222.xx.1 | 115.222.xx.1 | 115.222.xx.1 | 115.222.xx.1 |
| Jazline 200F nyomólap | 115.222.xx.1 | 115.222.xx.1 | 115.222.xx.1 | 115.222.xx.1 | 115.222.xx.1 | 115.222.xx.1 |
|  | 813.514.00.1 | 813.514.00.1 | 813.514.00.1 | 813.514.00.1 | 813.514.00.1 | 813.514.00.1 |
| Visszahúzó rugó | 813.514.00.1 | 813.514.00.1 | 813.514.00.1 | 813.514.00.1 | 813.514.00.1 | 813.514.00.1 |

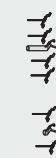







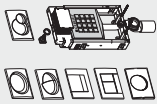
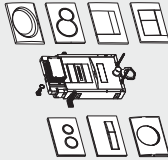
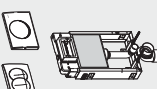

1.3.2 Falsík alatti öblítőtartály, előíról/fentről működtethető nyomólappal (1978-2004)









| | | | | | | |
|---|---|--|---|---|---|---|
|  | PA I/IX 2761/I | 1974-101 1981-101 1980-101 19805-101 |  |  |  |  |
| | PA I/IX 2761/I | 10.800 (átiátszó védőlap, sárgaréz rögzítőcsavarok (1978-1987) | PA I/IX 2761/I | PA I/IX 2761/I | PA I/IX 3403/I PA I/IX 3495/I PA I/IX 3535 | PA I/IX 3403/I PA I/IX 3495/I PA I/IX 3535 |
| | Átszerelő készlet, két mennyiségűs öblítésre (víztakarékos készlet) | 240.835.00.1 és 115.888.xx.1 nyomólap | 110.855/857 110.900 (fehér védőlap) (1988-1997) | 110.857/900 110.133 (1998-2004) | 110.962/963 (1986-1994) | 110.970/975 (1995-1999) |
| | Öblítőszelvény | 240.114.00.1 | 240.515.00.2 és 115.888.xx.1 nyomólap | - | - | - |
| | Öblítőszelvény kengyel készlet | 241.167.00.1 | 241.167.00.1 | 240.501.00.1 | 240.114.00.1 | 240.113.00.1 |
| | Öblítőszelvény tömítés | 816.418.00.1 (Ø 63x32) | 816.418.00.1 (Ø 63x32) | 816.418.00.1 (Ø 63x32) | 241.167.00.1 | 241.167.00.1 |
| | Impuls380 (Unifill) töltőszelvény | 240.705.00.1 | 240.705.00.1 | 240.705.00.1 | 240.705.00.1 + 240.321.00.1 ¹ | 240.705.00.1 |
| | Impuls380 (Unifill) töltőszelvény javítókészlet | 240.771.00.1 | 240.771.00.1 | 240.771.00.1 | 240.771.00.1 | 240.771.00.1 |

| | | | | | | |
|--|--|---|--------------------------------------|--------------------------------------|--------------------------------------|--------------------------------------|
|  | Flexibilis bekötőcső | - | 240.069.00.1 | 240.069.00.1 | 240.321.00.1 | 240.321.00.1 |
|  | Ajakos tömítés öblítőtartályhoz, d45 | 362.771.00.1 | 362.771.00.1 | 362.771.00.1 | 362.771.00.1 | 362.771.00.1 |
|  | Sarokszelvény | 216.599.00.1 | 216.599.00.1 | 216.599.00.1 | 216.599.00.1 | 216.599.00.1 |
|  | Öblítőszelvény kosár (cserélhető) | 240.195.00.1 | 240.195.00.1 | 240.500.00.1 | 240.195.00.1 | 240.195.00.1 |
|  | Szelvénykosár tömítőgyűrű | 240.282.00.1 | 240.282.00.1 | 240.282.00.1 | 240.282.00.1 | 240.282.00.1 |
|  | Rögztítő öblítőtartályhoz | 241.170.00.1 | 241.170.00.1 | 240.506.00.1 | 240.072.00.1 | 240.072.00.1 |
|  | Védőlap | 240.026.00.1 | 240.073.00.1 | 240.512.00.1 | - | - |
|  | Himba öblítőszelvényhez | - | 240.510.00.1 | 240.510.00.1 | - | - |
|  | Nyomólap | 115.222.xx.1 115.888.xx.1 | 115.222.xx.1 115.888.xx.1 | 115.222.xx.1 115.888.xx.1 | 115.333.xx.1 | 115.333.xx.1 |
|  | Átalakító készlet 115.333.xx.1 nyomólaphoz 1. Rövid 2. Hosszú | - | - | - | 240.175.00.1 (1) 240.178.00.1 (2) | 240.175.00.1 (1) 240.178.00.1 (2) |
|  | Hosszabbító készlet | - | 240.058.00.1 | 240.058.00.1 | 240.087.00.1 240.178.00.1 | 240.180.00.1 |
|  | 1. Nyomórúd 2. Távtartórúd | 240.074.00.1 (1) 216.024.00.1 (2) (sr) | 240.074.00.1 (1) 240.067.00.1 (2) | 240.074.00.1 (1) 240.067.00.1 (2) | - | 240.323.00.1 (1) |
|  | Hosszabbító az építési törmelék elleni védelemhez | 240.233.00.1 | 240.233.00.1 | 240.233.00.1 | - | - |
|  | Törőbetét öblítőtartályhoz 1. Egy mennyiségű öblítőszelvényhez 2. Két mennyiségű öblítőszelvényhez | 217.807.00.1 (1) 240.476.00.1 (2) | 217.807.00.1 (1) 240.476.00.1 (2) | 217.807.00.1 (1) 240.476.00.1 (2) | 240.476.00.1 (2) | 240.476.00.1 (2) |

A kompakt töltőszelvény Impus380 (Unifill) töltőszelvényre történő cseréjéhez szükséges a 240.321.00.1 összetekő cső.

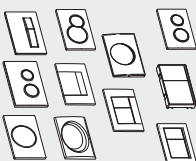







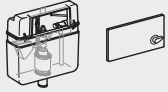
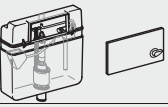
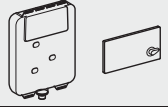
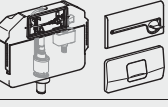

1.3.3 Falsík alatti öblítőtartály, előiról/fentről működtethető nyomólappal (1999-től)

| | | | | | | | |
|--|--|--|---|---|---|---|---|
|  | |  |  |  |  |  |  |
| | Viztakarékos öblítő-szelep rögzítővel | UP300 (2002-2008.03.) | UP320/Sigma (2008.04-től) | UP100/Delta (2005-től) | UP Artline (1999-2005) | UP200 (2006-2014) | Omega (2014-től) |
| | | 240.622.00.1 | 240.622.00.1 | 240.622.00.1 | 240.638.00.1 | 240.638.00.1 | 243.095.00.1 |
|  | Öblítőszepel kengyel készlet | 241.167.00.1 | 241.167.00.1 | 241.167.00.1 | 241.167.00.1 | 241.167.00.1 | 241.167.00.1 |
|  | Öblítőszepel tömítés | 816.418.00.1 (Ø 63x32) | 816.418.00.1 (Ø 63x32) | 816.418.00.1 (Ø 63x32) | 816.418.00.1 (Ø 63x32) | 816.418.00.1 (Ø 63x32) | 816.418.00.1 (Ø 63x32) |
|  | Öblítőszepel kosár | 241.859.00.1 | 241.859.00.1 | 241.859.00.1 | 241.859.00.1 | 241.859.00.1 | 243.096.00.1 (243.139.00.1 szorítógyűrűvel) |
| | Tömítógyűrű a 241.859.00.1-es szelepkosárhoz | 241.868.00.1 | 241.868.00.1 | 241.868.00.1 | 241.868.00.1 | 241.868.00.1 | - |
|  | Gyárilag szerelt szelepkosár tömítógyűrűje | 240.282.00.1 | 241.868.00.1 | 240.282.00.1 | 240.282.00.1 | 240.282.00.1 | 241.868.00.1 |
|  | Törölőbetét öblítőszepel-lephez | 240.476.00.1 | 240.476.00.1 | 240.476.00.1 | 240.476.00.1 | 240.476.00.1 | - |
|  | Impuls380 (Unifill) töltőszepel | 240.705.00.1 és 240.921.00.1 | 240.705.00.1 | 240.705.00.1 | 240.705.00.1 | 240.705.00.1 | 240.705.00.1 |
|  | Rögzítő klip Unifill töltőszepelhez | 240.923.00.1 | 240.923.00.1 | - | - | - | 243.088.00.1 |

| | | | | | | | | |
|---|--|--|--|--|--|--|--|--------------|
|  | 240.771.00.1 | 240.771.00.1 | 240.771.00.1 | 240.771.00.1 | 240.771.00.1 | 240.771.00.1 | 240.771.00.1 | 240.771.00.1 |
|  | 240.921.00.1 (1) 240.922.00.1 (2) | 240.921.00.1 (1) 240.922.00.1 (2) | 241.463.00.1 (1) | 240.329.00.1 (1) | 240.629.00.1 (1) | 240.629.00.1 (1) | 240.629.00.1 (1) 240.922.00.1 (2) | |
|  | 362.771.00.1 | 362.771.00.1 | 362.771.00.1 | 362.771.00.1 | 362.771.00.1 | 362.771.00.1 | 362.771.00.1 | 362.771.00.1 |
|  | 240.931.00.1 | 241.826.00.1 | 241.348.00.1 | 241.172.00.1 | 240.172.00.1 | 240.172.00.1 | 243.092.00.1 | |
|  | 240.930.00.1 | 241.824.00.1 | 241.343.00.1 | 241.206.00.1 | 240.206.00.1 | 240.206.00.1 | 243.089.00.1 | |
|  | 115.758.xx.1 115.778.xx.1 115.788.xx.1 115.750.xx.1 115.760.xx.1 115.770.xx.5 115.777.xx.1 115.751.00.1 (115.780.xx.1 már nem rendelhető) | 115.758.xx.1 115.778.xx.1 115.788.xx.1 115.750.xx.1 115.760.xx.1 115.770.xx.5 115.777.xx.1 115.751.00.1 | 115.120.xx.1 115.125.xx.1 115.130.xx.1 115.135.xx.1 115.100.xx.1 115.101.00.1 | 115.228.xx.1 115.260.xx.1 115.666.xx.1 | 115.228.xx.1 115.260.xx.1 115.666.xx.1 | 115.228.xx.1 115.260.xx.1 115.666.xx.1 | 115.085.xx.1 115.080.xx.1 115.081.xx.1 | |
|  | 241.829.00.1 | 241.829.00.1 | 241.349.00.1 | 240.079.00.1 | 240.533.00.1 | 240.079.00.1 | 243.091.00.1 | |
|  | 240.269.00.1 | 240.269.00.1 | 241.475.00.1 | 240.269.00.1 | 240.269.00.1 | 240.269.00.1 | 240.269.00.1 | |
|  | 241.857.00.1 | 241.857.00.1 | - | 241.857.00.1 | 241.857.00.1 | 241.857.00.1 | 241.857.00.1 | |
|  | 240.298.00.1 | 240.298.00.1 | 240.925.00.1 | 240.298.00.1 | 240.298.00.1 | 240.298.00.1 | 240.298.00.1 | |



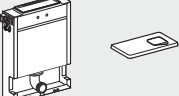
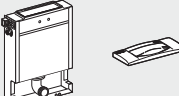
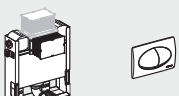
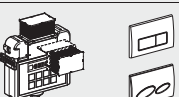







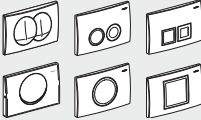



1.3.4 Falsík alatti öblítőtartályhoz használható flexibilis bekötőcső 240.705.00.1 töltőszelep használata esetén (1964-2008)

| Flexibilis cső | |  |  |  |  |  |  |  |
|---------------------------------|---|---|---|---|---|---|---|--|
| Öblítőtartály típusa | | 240.047.00.1 | 240.712.00.1 | 240.069.00.1 | 240.329.00.1 | 240.321.00.1 | 240.629.00.1 | 240.921.00.1 |
| 15.000 9 L 1964-1967 |  | X | | | | | | |
| 16.000 14 L 1965-1967 |  | X | | | | | | |
| 10.500 9 L 1970-1974 |  | | | | | | | |
| 10.600 14 L 1967-1970 |  | | X | | | | | |
| 10.600 14 L 1975-1978 |  | | | | | | | |
| 10.700 9 L 1972-től |  | X | | | | | | |
| 10.400 14 L 1978-1986 |  | | | X | | | | |
| 10.800 9 L 1975-1987 |  | | | | | | | |
| 110.800 6 - 9 L 1988-1998 |  | | | X | | | | |
| 110.800 6 - 9 L 1998-től |  | | | X | | | | |











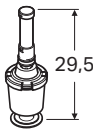

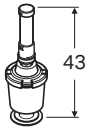

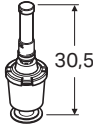

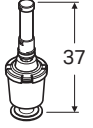

| | | Flexibilis cső |  |  |  |  |  |  |  |
|-------------------------------|--|----------------|---|---|---|---|---|---|--|
| Öblítőtartály típusa | | 240.047.00.1 | 240.712.00.1 | 240.069.00.1 | 240.329.00.1 | 240.321.00.1 | 240.629.00.1 | 240.921.00.1 | |
| 110.700 6-9 L 1988-tól |  | | | X | | | | | |
| 6-9 L 1986-1994 |  | | | | | X | | | |
| 6-9 L 1995-1998 |  | | | | | X | | | |
| Artline 6-9 L 1999-2006 |  | | | | X 1999 - 2001 | | X 2002 - 2006 | | |
| UP200 6-9 L 2006-től |  | | | | | | X | | |
| UP300 6-9 L 2001-2008 |  | | | | | | | X | |
| UP320 6-9 L 2008-től |  | | | | | | | X | |

1.4 Nyomólapok

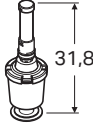



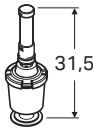













1.4.1 Nyomólapok UP öblítőtartályhoz elölről történő működtetéshez 2001-ig és UP100/Delta öblítőtartályokhoz (2005-től)

| | | Delta | Twinline | 200F | Highline |
|--|--|--|---|---|---|
| | |  |  |  |  |
| | | 115.100.xx.1 (2005-től) 115.101.00.1 (2006-től) 115.120.xx.1 115.125.xx.1 115.130.xx.1 115.135.xx.1 (2009-től) | 115.888.xx.1 (1998-től) | 115.222.xx.1 (1994-től) | 115.15x.xx.1 (1987-től) |
|  | Védőlap | 241.343.00.1 | 240.512.00.1 | 240.073.00.1 | 240.073.00.1 |
|  | Átlátszó védőlap emelőszerkezettel | – | – | – | 240.026.00.1 |
|  | Menetes szár, M6 | – | – | – | 216.024.00.1 |
|  | Nyomórúd | 241.465.00.1 (nyomó és rögzítőrúd készlet) | 240.074.00.1 | 240.074.00.1 | 240.074.00.1 |
|  | Távtartó rúd | | 240.067.00.1 | 240.067.00.1 | 240.067.00.1 |
|  | Visszahúzó rugó | 813.514.00.1 (csak a 115.101.00.1 cikkszámhoz) 241.295.00.1 (10db/cs.) | 813.514.00.1 | 813.514.00.1 | 813.514.00.1 |
|  | Nyomólap tartó keret | 242.274.00.1 | 240.513.00.1 | 240.068.00.1 | 240.068.00.1 |
|  | Elfordulást biztosító vezetőlap 2 mennyiségű nyomólaphoz | – | 240.514.00.1 | – | – |
|  | Megszakító kar | 241.465.00.1 (nyomó és rögzítőrúd készlet) | – | 240.066.00.1 | 240.066.00.1 |
|  | Hosszabbító készlet | 240.058.00.1 | 240.058.00.1 | 240.058.00.1 | 240.058.00.1 |

















1.4.2 Átszerelő készlet régi UP öblítőtartályok (1964-től) és Twinline / Jazzline 200F nyomólapokhoz

| A Geberit UP falsík alatti öblítőtartályok beazonosítása | | | | | Új | |
|---|---|--|--------------------------------|---|-------------------|--|
| Nyomólap | Öblítő-szelep | Öblítőtartály modellszám | PA-szám | Gyártási év | Átszerelő készlet | Nyomólap |
|  |  | Átszerelő készlet öblítés / stopra | | | | |
| | | 15.000 | PA-I/1115 | 1964 - 1967 | 215.420.00.1 |  115.222.xx.1 |
|  |  | 16.000 | – | 1965 - 1967 | 215.421.00.1 |  115.222.xx.1 |
|  |  | 10.500 10.520 | PA-I/IX1884/I PA-I/IX1885/I | 1970 - 1973 | 215.422.00.1 |  115.222.xx.1 |
|   |  | 10.600 -- | PA-I/ 1637 PA-I/IX1886/I | 1967 - 1971 1971 - 1973 1974 - 1977 | 215.423.00.1 |  115.222.xx.1 |
| | | 10.620 | PA-I/IX1887/I | 1967 - 1973 | | |
|    |  | 10.800 | PA-I/2331/I | 1975 - 1977 | 240.026.00.1 |  115.222.xx.1 |
| | | 10.400 | PA-I/2760/I | 1978 - 1986 | | |
| | | Átszerelő készlet 2 mennyiségű öblítésre | | | | |
| | | 10.800 (átlátszó védőlap, sárgaréz menetesszárral) | PA-I/IX2761/I | 1978 - 1987 | 240.835.00.1 |  115.888.xx.1 |
|   |  | 110.800 (fehér védőlap) | PA-I/IX2761/I | 1988 - 1997 | 240.515.00.2 |  115.888.xx.1 |











1.4.3 Nyomólapok előlről/fentről történő működtetéshez (1985-től)

| | | Kappa | Artline | | 300T | Fentről működtethető nyomólapok (Topline) | |
|--|--|---|---|---|---|---|--|
| | |  |  |  |  |  |  |
| | | 115.228.xx.1 115.260.xx.1 (2006-2015) | 115.666.xx.1 (2006-2007) | 115.666.xx.1 (1998-2005) | 115.333.xx.1 (1994-től) | 115.392.xx.1 (1985-től) | 115.394.xx.1 (1985-től) |
|  | Védőlap | 240.206.00.1 | 240.206.00.1 | 240.206.00.1 | - | - | - |
|  | Nyomó és távtartó rúd | 240.639.00.1 | 240.639.00.1 | 240.639.00.1 | - | - | - |
|  | Himba | - | - | - | - | 889.110.11.1 | - |
|  | Távtartó rúd nyomórúddal | - | - | - | 240.323.00.1 | - | - |
|  | Visszahúzó rugó | 241.295.00.1 (10 db) | 813.514.00.1 | 813.514.00.1 | 813.514.00.1 | 813.514.00.1 | 813.514.00.1 |
|  | Rögzítőkeret NUVO | - | - | - | - | - | 240.041.00.1 |
|  | Rögzítőkeret 300T-hez | - | - | - | 240.322.00.1 | - | - |
|  | Rögzítőkeret UP200 tartályok nyomólapjához | 240.646.00.1 | 240.646.00.1 | 240.646.00.1 | - | - | - |
|  | Hosszabbító készlet | 240.938.00.1 | 240.938.00.1 | 240.058.00.1 | 240.180.00.1 | 240.087.00.1 | - |
|  | Átszerelő készlet 300T-re | - | - | - | - | 240.175.00.1 | - |
|  | Átszerelő készlet 300T-re, hosszabbítóval | - | - | - | - | 240.178.00.1 | - |
|  | Átszerelő készlet UP Artline-hoz | 240.639.00.1 | - | - | - | - | - |













1.4.4 Nyomólapok falsík alatti tartályokhoz (Sigma/UP320/UP300), előlről történő működtetéshez (2002-től)

| | | Sigma40 | Sigma10 / Sigma20 / Sigma50 / Sigma30 | Sigma01 / Samba / Twist / Bolero | |
|--|--|---|---|--|--|
| | |  |  |  | |
| | | 115.600.xx.1 (2011-től) | 115.758.xx.1 115.778.xx.1 115.788.xx.1 (2008/04-től) 115.883.xx.1 115.893.xx.1 (2016-től) | 115.770.xx.x 115.777.xx.1 (2008/04-től) | 115.770.xx.1 115.777.xx.1 115.780.xx.1 (2002-2008/03) |
|  | Védőlap | 241.824.00.1 | 241.824.00.1 | 241.824.00.1 | 241.824.00.1 |
|  | Nyomó, távtartórúd és vezetőlap készlet | 241.874.00.1 | 241.874.00.1 | 241.874.00.1 | - |
|  | Nyomó, távtartórúd és vezetőlap készlet, csavarokkal | - | - | - | 241.875.00.1 |
|  | Elfordulást biztosító vezetőlap 2 mennyiségű nyomólaphoz | - | - | - | 240.934.00.1 |
|  | Visszahúzó rugó | - | 241.295.00.1 (10db/cs. csak a Sigma50-hez) | 813.514.00.1 (Sigma01-hez nem) | 813.514.00.1 |
|  | Nyomólap tartó keret 1. Nyomó- és távtartó rúddal | 242.524.00.1 | 241.873.00.1 (1.) | 241.873.00.1 (1.) | 240.935.00.1 |
|  | Hosszabbító készlet nyomólaphoz | - | 240.938.00.1 | 240.938.00.1 | 240.938.00.1 |
|  | Tartály bedobócsatornával | 242.602.00.1 | - | - | - |
|  | Működtető lapok | 242.601.xx.1 | - | - | - |
|  | Hálózati csatlakozó egység | 243.179.00.1 | - | - | - |
|  | Aktív szén szűrő ventilátorhoz | 242.555.00.1 | - | - | - |
|  | Hosszabbító ventilátorhoz | 242.525.00.1 | - | - | - |
|  | Szagelszívó egység ventilátorral | 242.523.00.1 | - | - | - |







1.4.4 Nyomólapok falsík alatti tartályokhoz (Sigma/UP320/UP300), előlről történő működtetéshez (2002-től)



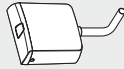
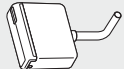
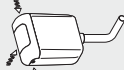
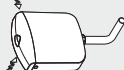
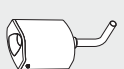
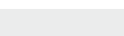

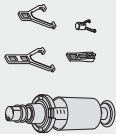

| | | Rumba / Tango | | Mambo | |
|---|--|---|--|---|--------------------------------|
| | |  | |  | |
| | | 115.750.xx.1 115.760.xx.1 (2008/04-től) | 115.750.xx.1 115.760.xx.1 (2002-2008/03) | 115.751.00.1 (2008/04-től) | 115.751.00.1 (2003-2008/03) |
|  | Védőlap | 241.824.00.1 | 241.824.00.1 | 241.824.00.1 | 241.824.00.1 |
|  | Nyomó, távtartórúd és vezetőlap készlet | 241.874.00.1 | – | 241.874.00.1 | – |
|  | Nyomó, távtartórúd és vezetőlap készlet, csavarokkal | – | 241.875.00.1 | – | 241.875.00.1 |
|  | Megszakító kar | – | 240.933.00.1 | – | 240.933.00.1 |
|  | Megszakító kar tartó Mambo nyomólaphoz | – | – | 241.878.00.1 | – |
|  | Visszahúzó rugó | 813.514.00.1 | 813.514.00.1 | 813.514.00.1 | 813.514.00.1 |
|  | Nyomólap tartó keret 1. Nyomó- és távtartó rúddal | 241.873.00.1 (1.) | 240.935.00.1 | 241.873.00.1 (1.) | 240.935.00.1 |
|  | Hosszabbító készlet nyomólaphoz | 240.938.00.1 | 240.938.00.1 | 240.938.00.1 | 240.938.00.1 |

1.4.5 Nyomólapok előlről/fentről történő működtetéshez (2014-től)





| | | Omega20 | Omega30 | Omega60 |
|--|---|---|---|---|
| | |  |  |  |
| | | 115.085.xx.1 (2014-től) | 115.080.xx.1 (2014-től) | 115.081.xx.1 (2014-től) |
|  | Védőlap | 243.089.00.1 | 243.089.00.1 | 243.089.00.1 |
|  | Nyomó és távtartó rúd | 242.588.00.1 | 242.588.00.1 | 242.588.00.1 |
|  | Ütközőrúd | – | – | 242.920.00.1 |
|  | Hosszabbító készlet nyomó és távtartó rúdhoz | 240.938.00.1 | 240.938.00.1 | – |
|  | Visszahúzó rugó | – | – | 813.514.00.1 |
|  | Rögzítőkeret | 243.108.00.1 | 243.108.00.1 | – |
|  | Kiegyenlítő keret | – | – | 243.109.00.1 |
|  | Távtartó elem | – | – | 243.110.00.1 |
|  | Működtető lapok | – | – | 243.118.xx.1 |







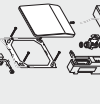

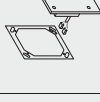
1.5 Falon kívüli öblítőtartályok

| | AP110 | AP112 | AP113 | AP117 | AP116 | AP116 plus |
|----------------------------|---|---|---|---|---|--|
| |  |  |  |  |  |  |
| | 136.610.11.1 (2003-től) | 136.230.xx.1 136.231.xx.1 (1991-2010) | 136.420.11.x (1994-2011) | 136.530.11.1 (2001-2010) | 136.430.11.1 (2011-től) | 136.444.11.1 (2011-től) |
| 1. Fedélnyomógombbal | 238.232.11.1 | 238.059.xx.1 (1.) | 238.062.11.1 | 238.187.11.1 | 238.082.11.1 (1.) | 238.085.11.1 (1.) |
| Nyomógomb | 238.233.11.1 | 238.064.xx.1 | 238.067.11.1 | 238.188.11.1 | - | - |
| Hímhatartó | 836.127.00.0 | - | 836.123.00.0 | 836.134.00.0 | - | - |
| Öblítőszelep | 238.234.00.1 | 238.080.00.1 | 238.081.00.1 | 238.189.00.1 | 238.117.00.1 | 238.116.00.1 |
| Tömítés öblítőszelephoz | 238.235.16.1 | 238.070.16.1 | 238.070.16.1 | 238.070.16.1 | 816.418.00.1 | 816.418.00.1 |
| Rögztő sablon | 836.032.00.0 | 836.033.00.0 | 836.032.00.0 | 836.033.00.0 | 836.032.00.0 | 836.032.00.0 |
| |  | | | | | |
| |  | | | | | |
| |  | | | | | |
| |  | | | | | |
| |  | | | | | |
| |  | | | | | |

| | | | | | | | | | |
|---|--------------|--|--|--------------|--------------|--------------|--------------|--------------|--------------|
|  | 136.703.00.1 | 136.703.00.1 | 136.703.00.1 | 136.703.00.1 | 136.703.00.1 | 136.703.00.1 | 136.703.00.1 | 136.703.00.1 | 136.703.00.1 |
|  | 238.074.11.1 | 238.074.11.1 | 238.073.11.1 | 238.074.11.1 | 238.191.11.1 | 238.073.11.1 | 238.073.11.1 | 238.073.11.1 | 238.073.11.1 |
|  | - | 238.071.00.1 (1) 238.072.00.1 (2) | 238.071.00.1 (1) 238.072.00.1 (2) | - | - | - | - | - | - |
|  | 119.668.00.1 | 119.668.00.1 | 119.668.00.1 | 119.668.00.1 | 119.668.00.1 | 119.668.00.1 | 119.668.00.1 | 119.668.00.1 | 119.668.00.1 |
|  | 238.075.11.1 | 238.075.11.1 | 238.075.11.1 | 238.075.11.1 | 238.075.11.1 | 238.075.11.1 | 238.075.11.1 | 238.075.11.1 | 238.075.11.1 |
|  | - | 238.077.11.1 | 238.077.11.1 | - | - | - | - | - | - |
|  | 238.069.00.1 | 238.069.00.1 | 238.069.00.1 | 238.069.00.1 | 238.069.00.1 | 238.069.00.1 | 238.069.00.1 | 238.069.00.1 | 238.069.00.1 |



1.6 Vizelde vezérlékek
1.6.1 Infravörös illetve radar müködttetésű vizelde vezérlékek (1979-2001)

| Tápegység | |  |  |  |  |  |  |
|-----------|---|---|---|---|---|---|---|
| | | 142.065 (1990-1992) 115.552 (1992-1994) | 115.580 (1994-1998) | 142.061 (1987-1992) 115.555 (1994-1998) | 115.566 (1991-2001) | 142.050' (1983-1986) 142.055' (1987-1991) | 115.400 (1979-1981) |
| | Átszerelő készlet előlappal, új infrás vezérléssel | Elemes | Elemes | Hálózati | Elemes | Hálózati | Elemes |
| | - Előlap nélküli átszerelő készlet, mágnesszeleppel új infrás vezérléssel | 240.850.00.1 | 240.850.00.1 | 240.841.00.1 | 240.841.00.1 | 240.841.00.1 | 240.841.00.1 |
| | - Előlap | 240.043.xx.1 | 240.043.xx.1 | 240.043.xx.1 | 240.150.00.1 | 240.150.00.1 | - |
| | - Előlaprögztő csavar M4x20 | 243.048.00.1 | 243.048.00.1 | 243.048.00.1 | 243.048.00.1 | 243.048.00.1 | - |
| | Rögztőkeret laposfejű csavarral | 243.047.00.1 | 243.047.00.1 | 243.047.00.1 | 243.047.00.1 | 243.047.00.1 | 243.047.00.1 |
| | Elzárószelep komplett | 243.005.00.1 | 243.005.00.1 | 243.005.00.1 | 243.005.00.1 | 243.005.00.1 | - |
| | - Szennyfogyó szűrő | 243.013.00.1 | 243.013.00.1 | 243.013.00.1 | 243.013.00.1 | 243.013.00.1 | - |
| | - Elzáró szeleporzó | 243.012.00.1 | 243.012.00.1 | 243.012.00.1 | 243.012.00.1 | 243.012.00.1 | - |
| | Mágnesszelep 12V | 240.142.00.1 | 240.343.00.1 | - | - | - | - |
| | Mágnesszelep 24V | - | - | 240.803.00.1 | 240.803.00.1 | 240.803.00.1 | 240.803.00.1 |
| | Műanyag csöcsatlakozó lapostömítéssel, anyával | 243.007.00.1 | 243.007.00.1 | 243.007.00.1 | 243.007.00.1 | 243.007.00.1 | 243.007.00.1 |



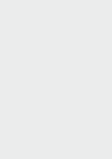
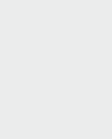

| | | | | | | | |
|---|--------------|--------------|--------------|--------------|---------------------------------|---------------------------------|--------------|
|  | 241.061.00.1 | 241.061.00.1 | 241.061.00.1 | 241.061.00.1 | 241.061.00.1 | 241.061.00.1 | 241.061.00.1 |
|  | 854.467.00.0 | 854.467.00.0 | 854.467.00.0 | 854.467.00.0 | 854.467.00.0 | 854.467.00.0 | 854.467.00.0 |
|  | 243.008.00.1 | 243.008.00.1 | 243.008.00.1 | 243.008.00.1 | 243.008.00.1 | 243.008.00.1 | 243.008.00.1 |
|  | 240.143.00.1 | 2 CR5/6 V | - | - | - | - | - |
|  | - | - | 243.009.00.1 | 243.009.00.1 | 243.009.00.1 | 243.009.00.1 | 243.009.00.1 |
|  | - | - | - | - | megszűnt, infrássá átszerelhető | megszűnt, infrássá átszerelhető | - |
|  | - | - | - | - | 240.874.00.1 megszűntetve | - | - |
|  | - | - | - | - | 115.565.00.1 megszűntetve | - | - |





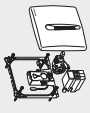

1. A radáros működetésű vezérléshez az antennamodul (240.874.00.1) és a beépítő készlet (115.565.00.1) már nem rendelhető. A 240.841.00.1 átszerelő készlettel infrás vezérléssé átalakítható.

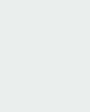
1.6.2 Infravörös működtetésű vizelde vezérlések (1999-től)

| Tápegység | (1999-2013) | | (2013-tól) | | Képek |
|---|--------------|--------------|--------------|--------------|---|
| | Hálózati | Elemes | Hálózati | Elemes | |
|  | 240.560.xx.1 | 240.560.xx.1 | 240.560.xx.1 | 240.560.xx.1 |  115.802.xx.1 |
| | 240.565.00.1 | 240.565.00.1 | 240.565.00.1 | 240.565.00.1 |  115.804.xx.5 |
| Infra ablak | 240.525.00.1 | 240.525.00.1 | 240.525.00.1 | 240.525.00.1 |  115.805.21.1 |
| Rögítőkeret | 240.521.00.1 | 240.521.00.1 | 240.521.00.1 | 240.521.00.1 | (2001-től) |
| Infra érzékelő | 240.524.00.1 | 240.524.00.1 | 242.775.00.1 | 242.775.00.1 | Elemes |
| Mágnesszelep | 240.523.00.1 | 240.523.00.1 | 242.770.00.1 | 242.770.00.1 | 240.891.46.1 |
| Hálózati transzformátor illetve Lithium-elem | 240.531.00.1 | 240.535.00.1 | 242.774.00.1 | 241.945.00.1 | Hengerfej csavar, M4x10mm inbusznyílással |
| Vízelosztó, fekete (flexibilis csővel történő bekötéshez, gyártási év 2005-2008) | 240.035.00.1 | 240.035.00.1 | - | - | 240.892.00.1 |
| Vízelosztó PE-csőhöz, szűrke | 240.517.00.1 | 240.517.00.1 | - | - | - |
| Lapos tömítés | 240.871.00.1 | 240.871.00.1 | - | - | - |
| Szűrőtartó, szűrő és fojtószelep csavarzat | 241.060.00.1 | 241.060.00.1 | - | - | - |
| Szűrő | 240.520.00.1 | 240.520.00.1 | - | - | - |
| EPDM gumitömítés d32 mm | 243.008.00.1 | 243.008.00.1 | - | - | - |











1.6.3 Infravörös működtetésű vizelde vezérlések (1999-től)

| Tápegység | (1999-2013) | | (2013-tól) | | (2003-2010) | |
|---|--------------|--------------|--------------|------------------------------------|--------------|--------------|
| | Hálózati | Elemes | Hálózati | Elemes | Hálózati | Elemes |
|  Előlap infra ablakkal | 115.817.xx.1 | 115.818.xx.1 | 115.817.xx.5 | 115.818.xx.5 | 115.825.00.1 | 115.826.00.1 |
| | 240.966.xx.1 | 240.966.xx.1 | 240.966.xx.1 | 240.966.xx.1 | 241.162.xx.1 | 241.162.xx.1 |
|  Előlaprögzítő retesz | 240.565.00.1 | 240.565.00.1 | 240.565.00.1 | 240.565.00.1 | 240.565.00.1 | 240.565.00.1 |
| | - | - | - | - | 241.323.00.1 | 241.323.00.1 |
|  Rögzítőkeret | 240.521.00.1 | 240.521.00.1 | 240.521.00.1 | 240.521.00.1 | 240.521.00.1 | 240.521.00.1 |
| | 240.524.00.1 | 240.524.00.1 | 242.775.00.1 | 242.775.00.1 | 240.524.00.1 | 240.524.00.1 |
|  Mágnesszelep | 240.523.00.1 | 240.523.00.1 | 242.770.00.1 | 242.770.00.1 | 240.523.00.1 | 240.523.00.1 |
| | 240.531.00.1 | 240.535.00.1 | 242.774.00.1 | 241.945.00.1 elemtartó doboz | 240.531.00.1 | 240.535.00.1 |
|  Hálózati csatlakozás burkolata | 240.522.00.1 | 240.522.00.1 | 240.522.00.1 | 240.522.00.1 | 240.522.00.1 | 240.522.00.1 |
| | 240.522.00.1 | 240.522.00.1 | 240.522.00.1 | 240.522.00.1 | 240.522.00.1 | 240.522.00.1 |





| | | | | | | | | |
|---|--|--------------|--------------|--------------|--------------|--------------|--------------|--------------|
|  | Vízelosztó, fekete (flexibilis csővel történő bekötéshez, gyártási év 2005-2008) | 240.035.00.1 | 240.035.00.1 | - | - | 240.035.00.1 | 240.035.00.1 | 240.035.00.1 |
| | Vízelosztó PE-csőhöz, szürke | 240.517.00.1 | 240.517.00.1 | - | - | 240.517.00.1 | 240.517.00.1 | 240.517.00.1 |
|  | Lapos tömítés | 240.871.00.1 | 240.871.00.1 | - | - | 240.871.00.1 | 240.871.00.1 | 240.871.00.1 |
| | Szűrőtartó, szűrő és fojtószelep csavarzat | 241.060.00.1 | 241.060.00.1 | - | - | 241.060.00.1 | 241.060.00.1 | 241.060.00.1 |
|  | Szűrő | 240.520.00.1 | 240.520.00.1 | - | - | 240.520.00.1 | 240.520.00.1 | 240.520.00.1 |
| | EPDM gumitömítés d32 mm | 243.008.00.1 | 243.008.00.1 | - | - | 243.008.00.1 | 243.008.00.1 | 243.008.00.1 |
|  | Elzáró és fojtószelep | - | - | 242.789.00.1 | 242.789.00.1 | - | - | - |
| | Fojtószelep | - | - | 241.933.00.1 | 241.933.00.1 | - | - | - |
|  | Szűrőkosár | - | - | 241.932.00.1 | 241.932.00.1 | - | - | - |
| | Áramlásszabályzó rövidített | - | - | 242.771.00.1 | 242.771.00.1 | - | - | - |
|  | Gumitömítés mágnesszelephez | - | - | 242.772.00.1 | 242.772.00.1 | - | - | - |





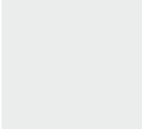
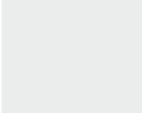
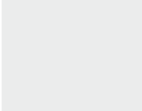
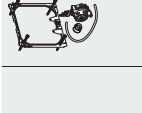
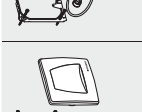
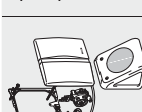

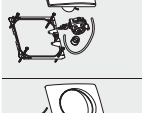
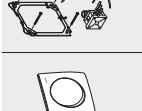
1.6.4 HyTronic érintésmentes vizelde vezérlések (2009-től)

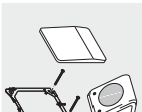
| Típus | Samba / Sigma01 | Bolero | Mambo | Tango | Sigma10 | Sigma50 | Rejtett vizelde vezérlés |
|--|----------------------------|----------------------------|----------------------------|----------------------------|----------------------------|----------------------------|--------------------------|
| Hálózatról működő cikkszám | 116.021.xx.x | 116.022.xx.1 | 116.023.FW.1 | 116.024.xx.1 | 116.025.xx.1 | 116.026.GH.1 | 116.010.00.1 |
| Elemről működő cikkszám | 116.031.xx.x (2009-től) | 116.032.xx.1 (2009-től) | 116.033.FW.1 (2009-től) | 116.034.xx.1 (2009-től) | 116.035.xx.1 (2009-től) | 116.036.GH.1 (2009-től) | (2009-től) |
| Elzáró és fojtószelep | 241.934.00.1 | 241.934.00.1 | 241.934.00.1 | 241.934.00.1 | 241.934.00.1 | 241.934.00.1 | 241.934.00.1 |
| Fojtószelep | 241.933.00.1 | 241.933.00.1 | 241.933.00.1 | 241.933.00.1 | 241.933.00.1 | 241.933.00.1 | 241.933.00.1 |
| Távtartó rúd készlet | 241.931.00.1 | 241.931.00.1 | 241.931.00.1 | 241.931.00.1 | 241.931.00.1 | 241.931.00.1 | 241.931.00.1 |
| Érzékelő elektronika | 241.941.00.1 | 241.941.00.1 | 241.941.00.1 | 241.941.00.1 | 241.941.00.1 | 241.941.00.1 | - |
| Tápegység | 241.944.00.1 | 241.944.00.1 | 241.944.00.1 | 241.944.00.1 | 241.944.00.1 | 241.944.00.1 | 241.944.00.1 |
| Elemtartó doboz | 241.945.00.1 | 241.945.00.1 | 241.945.00.1 | 241.945.00.1 | 241.945.00.1 | 241.945.00.1 | - |
| Vizelde rögzítő keret vízszintes (1.) vagy függőleges (2.) | 241.942.00.1 (2.) | 241.942.00.1 (2.) | 241.942.00.1 (2.) | 241.943.00.1 (1) | 241.942.00.1 (2.) | 241.942.00.1 (2.) | - |





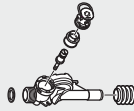
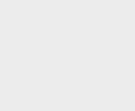
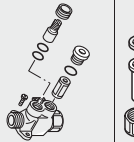

| | | | | | | | | |
|--|--|--|--------------|--------------|--------------|--------------|--------------|--------------|
|  | Fedél infra vezérléshez | 241.921.xx.1 (Samba) 242.821.xx.1 (Sigma01) | 241.922.xx.1 | 241.923.FW.1 | 241.924.xx.1 | 241.925.xx.1 | 241.926.GH.1 | - |
| | Infra ablak | 241.901.00.1 (Samba) 241.905.00.1 (Sigma01) | 241.902.00.1 | 241.903.00.1 | 241.904.00.1 | 241.905.00.1 | 241.906.00.1 | - |
|  | Sorkapocs fedéllel | 241.947.00.1 | 241.947.00.1 | 241.947.00.1 | 241.947.00.1 | 241.947.00.1 | 241.947.00.1 | 241.947.00.1 |
|  | Mágnesszelep | 241.946.00.1 | 241.946.00.1 | 241.946.00.1 | 241.946.00.1 | 241.946.00.1 | 241.946.00.1 | 241.946.00.1 |
|  | Szűrőkosár | 241.932.00.1 | 241.932.00.1 | 241.932.00.1 | 241.932.00.1 | 241.932.00.1 | 241.932.00.1 | 241.932.00.1 |
|  | Ajkos tömítés szeleptest fedéllel | 242.156.00.1 | 242.156.00.1 | 242.156.00.1 | 242.156.00.1 | 242.156.00.1 | 242.156.00.1 | 242.156.00.1 |
|  | Áramlásszabályzó | 242.484.00.1 | 242.484.00.1 | 242.484.00.1 | 242.484.00.1 | 242.484.00.1 | 242.484.00.1 | 242.484.00.1 |
|  | Fröcskölésvédő, rejtett | - | - | - | - | - | - | 242.155.00.1 |
|  | Elektronika modul, rejtett | - | - | - | - | - | - | 242.154.00.1 |
|  | Rögzítő klip érzékelővel | - | - | - | - | - | - | 242.152.00.1 |
|  | Univerzális vízelészifon, érzékelővel együtt | - | - | - | - | - | - | 242.150.00.1 |

1.6.5 Pneumatikus működtetésű vizelde vezérlések (1987-től)

| | | | | | | | | | | | |
|---|---|---|---|--|---|---|---|---|---|---|---|
|  |  |  |  |  |  |  |  |  |  |  |  |
| | 115.808.xx.1 (1999-2005) | 115.809.xx.1 (1999-2010) | 115.819.xx.1 115.820.xx.1 (2010-2013) | 115.820.xx.5 (2013-től) | 115.828.00.1 (2003-2010) | 115.558 (1993-1998) | 142.070 (1987-1992) 115.482 (1992-1998) | | | | |
| | 240.562.xx.1 | 240.561.xx.1 | 241.319.xx.1 | 241.319.xx.1 | 241.164.00.1 | 240.121.xx.1 | 240.150.00.1 | | | | |
| | 240.565.00.1 | 240.565.00.1 | 240.565.00.1 | 240.565.00.1 | 240.565.00.1 | - | 243.048.00.1 | | | | |
| | 240.521.00.1 | 240.521.00.1 | 240.521.00.1 | 240.521.00.1 | 240.521.00.1 | 243.047.00.1 | 243.047.00.1 | | | | |
| | - | - | - | - | - | 240.048.xx.1 | - | | | | |
| | - | 240.872.00.1 | - | - | - | - | 240.872.00.1 | | | | |
| | 240.519.00.1 | 240.519.00.1 | 240.519.00.1 | - | 240.519.00.1 | 240.870.00.1 | 240.870.00.1 | | | | |
| | 886.241.00.1 | 886.241.00.1 | 886.241.00.1 | - | 886.241.00.1 | 886.241.00.1 | 886.241.00.1 | | | | |
| | 256.000.00.1 | 256.000.00.1 | 256.000.00.1 | - | 256.000.00.1 | 256.000.00.1 | 256.000.00.1 | | | | |
| | - | - | - | 242.789.00.1 | - | - | - | | | | |
| | - | - | - | 241.933.00.1 | - | - | - | | | | |
| | | | | | | | | | | | |



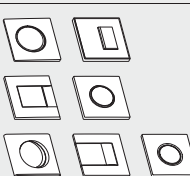









| | | | | | | | | |
|---|--|--------------|--------------|--------------|--------------|--------------|--------------|--------------|
|  | Pneumatikus szelep | - | - | - | 242.790.00.1 | - | - | - |
|  | Hálózati csatlakozás burkolata | 240.522.00.1 | 240.522.00.1 | 240.522.00.1 | 240.522.00.1 | 240.522.00.1 | - | - |
|  | Áramlásszabályzó, rövidített | - | - | - | 242.771.00.1 | - | - | - |
|  | Szűrőkösár | - | - | - | 241.932.00.1 | - | - | - |
|  | Vízelosztó, fekete (flexibilis csővel történő bekötéshez, gyártási év 2005-2008) | 240.035.00.1 | 240.035.00.1 | 240.035.00.1 | - | 240.035.00.1 | - | - |
| | Vízelosztó PE-csőhöz, szürke | 240.517.00.1 | 240.517.00.1 | 240.517.00.1 | - | 240.517.00.1 | - | - |
|  | - Lapos tömítés | 240.871.00.1 | 240.871.00.1 | 240.871.00.1 | - | 240.871.00.1 | 240.871.00.1 | 240.871.00.1 |
| | - Szűrőtartó, szűrő és fojtószelep csavarzat | 241.060.00.1 | 241.060.00.1 | 241.060.00.1 | - | 241.060.00.1 | - | - |
| | - Szűrő | 240.520.00.1 | 240.520.00.1 | 240.520.00.1 | - | 240.520.00.1 | - | - |
| | - EPDM gumitömítés d32 mm | 243.008.00.1 | 243.008.00.1 | 243.008.00.1 | 242.772.00.1 | 243.008.00.1 | 243.008.00.1 | 243.008.00.1 |
|  | Elzárószelep komplett | - | - | - | - | - | 243.005.00.1 | 243.005.00.1 |
| | - Szennyfogó szűrő | - | - | - | - | - | 243.013.00.1 | 243.013.00.1 |
| | - Elzáró szeleporzó | - | - | - | - | - | 243.012.00.1 | 243.012.00.1 |
|  | Műanyag csőcsatlakozó lapostömítéssel, anyával | - | - | - | - | - | 243.007.00.1 | 243.007.00.1 |
| | Sárgaréz csőcsatlakozó, lapostömítéssel, anyával | - | - | - | - | - | 241.061.00.1 | 241.061.00.1 |
|  | Közcsovár R3/4 | - | - | - | - | - | 854.467.00.0 | 854.467.00.0 |



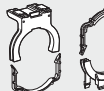





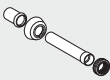

1.6.6 HyTouch pneumatikus működtetésű vizelde vezérlések (2009-től)

| Típus | Samba / Sigma01 | Bolero | Mambo | Tango | Sigma10 | Sigma50 | Sigma50 |
|--|--|----------------------------|----------------------------|----------------------------|----------------------------|-----------------------------|----------------------------|
| Cikkszám | 116.011.xx.x (2009-től) | 116.012.xx.1 (2009-től) | 116.013.FW.1 (2009-től) | 116.014.xx.1 (2009-től) | 116.015.xx.1 (2009-től) | 116.016.xx.1 (2009-2014) | 116.016.xx.5 (2013-től) |
|  | 241.934.00.1 | 241.934.00.1 | 241.934.00.1 | 241.934.00.1 | 241.934.00.1 | 241.934.00.1 | 241.934.00.1 |
|  | 241.933.00.1 | 241.933.00.1 | 241.933.00.1 | 241.933.00.1 | 241.933.00.1 | 241.933.00.1 | 241.933.00.1 |
|  | 241.931.00.1 | 241.931.00.1 | 241.931.00.1 | 241.931.00.1 | 241.931.00.1 | 241.931.00.1 | 241.931.00.1 |
|  | 241.937.00.1 | 241.937.00.1 | 241.937.00.1 | 241.937.00.1 | 241.937.00.1 | 241.937.00.1 | 241.937.00.1 |
|  | 241.935.00.1 | 241.935.00.1 | 241.935.00.1 | 241.935.00.1 | 241.935.00.1 | 241.935.00.1 | 241.935.00.1 |
|  | 241.911.xx.1 (Samba) 242.811.xx.1 (Sigma01) | 241.912.xx.1 | 241.913.FW.1 | 241.914.xx.1 | 241.915.xx.1 | 241.916.xx.x | 241.916.xxx |
|  | 241.936.00.1 | 241.936.00.1 | 241.936.00.1 | 241.936.00.1 | 241.936.00.1 | 241.936.00.1 | 241.936.00.1 |

















1.7 Kiegészítők

1.7.1 WC öblítőtartály és vizelde csatlakozó elemek

| | Termékleírás | Cikkszám |
|--|--|--|
|  | Galléros PE csőcsatlakozó d90 Galléros PE csőcsatlakozó d110 | 152.426.46.1 152.422.46.1 |
|  | PE öblítőcső falsík alatti tartályhoz, d45 | 152.434.16.1 |
|  | PE öblítőcső hosszabbító falsík alatti tartályhoz, d45 | 361.887.16.1 |
|  | PE csatlakozó készlet fali WC-hez, szintkülönbség emelés 2,5 cm • excentrikus WC bekötőcső d90, 25mm • excentrikus WC bekötőcső d110, 25mm Menetes szár M12, 2,5 cm-es szintemeléshez | 405.116.00.1 405.012.00.1 240.284.00.1 |
|  | Fedőkupak készlet WC-hez, szürke Fedőkupak készlet WC-hez, fehér Fedőkupak készlet vizeldéhez, szürke | 217.713.46.1 217.713.11.1 240.027.46.1 |
|  | EPDM gumigyűrű galléros csőcsatlakozóhoz • 152.400/420/422/425/426-hoz 152.435/439, 115.441-hez 367.880/898-hoz • 152.400.16.1-hez 152.610-616, 152.623-hoz • 152.421.46.1, 152.440.46.1, 152.486.16.1-hez | 152.424.00.1 152.497.00.1 854.487.00.1 895.589.00.1 |
|  | Lefolyóív tartóbilincs konzollal Duofix szerelőelemhez Lefolyóív tartóbilincs konzollal Kombifix szerelőelemhez | 242.012.00.1 240.190.00.1 |
|  | Gumimandzsetta fali WC lefolyóívhez d90 Gumimandzsetta fali WC lefolyóívhez d110 (1995-ig gyártottakhoz) Gumimandzsetta fali WC lefolyóívhez d110 (1996-tól gyártottakhoz) | 387.282.00.1 367.789.00.1 240.813.00.1 |
|  | Vizelde csatlakozó ív, d50 Tömítés vizelde csatlakozó ívhez d65-d50 | 152.231.11.1 894.319.00.1 |
|  | PE csatlakozó készlet vizeldéhez, d50 | 152.608.46.1 |
|  | PE bekötőcső vizeldéhez, d32 | 152.489.16.1 |
|  | Egyrészes takaró rozetta, d50 | 854.188.11.1 |
|  | Gumitömítés vizelde szifonhoz • d50 csatlakozáshoz | 358.826.00.1 |

| | Termékleírás | Cikkszám |
|--|--|--------------|
|  | Tömítőgitt | 990.937.00.1 |
|  | Öblítőcső hamónikatömítés d44 | 119.668.00.1 |
|  | Öblítőoldali bekötőkészlet talpon álló WC-hez | 118.026.xx.1 |
|  | WC bekötőcső, d110, H35 | 152.613.11.1 |
|  | WC lefolyóív 90°, hosszabbított, d110, H29 | 152.614.11.1 |
|  | WC lefolyócsatlakozó készlet, d110, rögzíthető, hátsó kifolyású WC-hez | 152.647.11.1 |
|  | WC lefolyócsatlakozó, excenteres, 3 cm | 131.085.11.1 |
|  | WC lefolyócsatlakozó, excenteres, 7 cm | 131.108.11.1 |
|  | Monolith talpon álló WC-hez öblítőcső készlet, P-könyökkel, PP | 131.081.11.1 |
|  | Monolith talpon álló WC-hez öblítőcső készlet, 90°-os, PE | 131.082.16.1 |
|  | Monolith fali WC-hez öblítőcső készlet | 131.084.16.1 |

1.7.2 Kád és zuhany alkatrészek

| | Termékleírás | Cikkszám |
|--|---|--|
|  | Működtető készlet: forgató gomb és szelepfedél kádszifonhoz, 1986-tól | 150.221.21.1 |
|  | Forgatógomb tartó kádlefolyóhoz, 1998-tól | 240.458.00.1 |
|  | Forgatógomb tartó kádlefolyóhoz, 1998-ig | 240.457.00.1 |
|  | Rögzítő készlet kádszifon túlfolyóhoz, 1998-tól | 240.459.00.1 |
|  | Tömítés d50 | 893.601.00.1 |
|  | Takarórózsa láncsal és dugóval, 1986-ig | 255.108.00.1 |
|  | Takarórózsa láncsal és dugóval, 1987-től | 216.983.00.1 |
|  | Dugó láncsal, fényes króm | 240.468.21.1 |
|  | Lefolyószelep készlet, 1997-ig Lefolyószelep készlet, 1997-től | 216.986.00.1 240.465.00.1 |
|  | Akril kádhoz d52 kádlefolyó csatlakozó készlet | 150.247.00.1 |
|  | T-idom vízmelegítő csatlakoztatásához, 1998-tól Túlfolyó hosszabító, d32 | 150.245.06.1 240.464.06.1 |
|  | PE-HD lefolyócső d40/50, 45°, kádlefolyóhoz | 854.454.00.1 |
|  | Állócső, fényes króm | 352.348.21.1 |
|  | Állócső, átlátszó plexi | 352.348.00.1 |
|  | Szelepfedél és dugó Clou lefolyóhoz, 1 1/4" | 858.257.00.1 |
|  | Szelepfedél Clou lefolyóhoz | 241.504.00.1 240.750.21.1 241.993.xx.1 |

| Cikkszám | Oldal | Cikkszám | Oldal | Cikkszám | Oldal |
|--------------|------------------|--------------|----------------|--------------|------------------|
| 110.000/500 | 5, 7 | 115.828.00.1 | 32 | 152.497.00.1 | 36 |
| 110.000/600 | 5,7 | 115.883.xx.1 | 19 | 152.608.46.1 | 36 |
| 110.133 | 10 | 115.888.xx.1 | 10, 11, 16, 17 | 152.610 | 36 |
| 110.700 | 15 | 115.893.xx.1 | 19 | 152.611 | 36 |
| 110.800 | 14, 17 | 116.010.00.1 | 30 | 152.612 | 36 |
| 110.855 | 10 | 116.011.xx.x | 34, 35 | 152.613 | 36 |
| 110.857 | 10 | 116.012.xx.1 | 34, 35 | 152.613.11.1 | 37 |
| 110.900 | 10 | 116.013.FW.1 | 34, 35 | 152.614 | 36 |
| 110.962 | 10 | 116.014.xx.1 | 34, 35 | 152.614.11.1 | 37 |
| 110.963 | 10 | 116.015.xx.1 | 34, 35 | 152.615 | 36 |
| 110.970 | 10 | 116.016.xx.1 | 34, 35 | 152.616 | 36 |
| 110.975 | 10 | 116.016.xx.5 | 34, 35 | 152.623 | 36 |
| 115.080.xx.1 | 13, 21 | 116.021.xx.x | 30 | 152.647.11.1 | 37 |
| 115.081.xx.1 | 13, 21 | 116.022.xx.1 | 30 | 215.420.00.1 | 8, 17 |
| 115.085.xx.1 | 13, 21 | 116.023.FW.1 | 30 | 215.421.00.1 | 8, 17 |
| 115.100.xx.1 | 13, 16 | 116.024.xx.1 | 30 | 215.422.00.1 | 8, 17 |
| 115.101.00.1 | 13, 16 | 116.025.xx.1 | 30 | 215.423.00.1 | 8, 17 |
| 115.120.xx.1 | 13, 16 | 116.026.GH.1 | 30 | 216.024.00.1 | 9, 11, 16 |
| 115.125.xx.1 | 13, 16 | 116.031.xx.x | 30 | 216.024.00.1 | 9, 11, 16 |
| 115.130.xx.1 | 13, 16 | 116.032.xx.1 | 30 | 216.599.00.1 | 5, 9, 11 |
| 115.135.xx.1 | 13, 16 | 116.033.FW.1 | 30 | 216.983.00.1 | 38 |
| 115.222.xx.1 | 8, 9, 11, 16, 17 | 116.034.xx.1 | 30 | 216.986.00.1 | 38 |
| 115.228.xx.1 | 13, 18 | 116.035.xx.1 | 30 | 217.713.11.1 | 36 |
| 115.260.xx.1 | 13, 18 | 116.036.GH.1 | 30 | 217.713.46.1 | 36 |
| 115.333.xx.1 | 11, 18 | 118.026.xx.1 | 37 | 217.807.00.1 | 11 |
| 115.392.xx.1 | 18 | 119.668.00.1 | 23, 37 | 217.807.00.1 | 11 |
| 115.394.xx.1 | 18 | 131.081.11.1 | 37 | 238.059.xx.1 | 22 |
| 115.400 | 24 | 131.082.16.1 | 37 | 238.062.11.1 | 22 |
| 115.441 | 36 | 131.084.16.1 | 37 | 238.064.xx.1 | 22 |
| 115.482 | 32 | 131.085.11.1 | 37 | 238.067.11.1 | 22 |
| 115.552 | 24 | 131.108.11.1 | 37 | 238.069.00.1 | 23 |
| 115.555 | 24 | 136.230.xx.1 | 22 | 238.070.16.1 | 22 |
| 115.558 | 32 | 136.231.xx.1 | 22 | 238.071.00.1 | 23 |
| 115.565.00.1 | 25 | 136.420.11.x | 22 | 238.072.00.1 | 23 |
| 115.566 | 24 | 136.430.11.1 | 22 | 238.073.11.1 | 23 |
| 115.580 | 24 | 136.444.11.1 | 22 | 238.074.11.1 | 23 |
| 115.600.xx.1 | 19 | 136.530.11.1 | 22 | 238.075.11.1 | 23 |
| 115.666.xx.1 | 13, 18 | 136.610.11.1 | 22 | 238.077.11.1 | 23 |
| 115.750.xx.1 | 13, 20 | 136.703.00.1 | 23 | 238.080.00.1 | 22 |
| 115.751.00.1 | 13, 20 | 142.050 | 24 | 238.081.00.1 | 22 |
| 115.758.xx.1 | 13, 19 | 142.055 | 24 | 238.082.11.1 | 22 |
| 115.760.xx.1 | 13, 20 | 142.061 | 24 | 238.085.11.1 | 22 |
| 115.770.xx.1 | 19 | 142.065 | 24 | 238.112.00.1 | 22 |
| 115.770.xx.5 | 13 | 142.070 | 32 | 238.116.00.1 | 22 |
| 115.770.xx.x | 19 | 150.221.21.1 | 38 | 238.117.00.1 | 22 |
| 115.777.xx.1 | 13, 19 | 150.245.06.1 | 38 | 238.187.11.1 | 22 |
| 115.778.xx.1 | 13, 19 | 150.247.00.1 | 38 | 238.188.11.1 | 22 |
| 115.780.xx.1 | 13, 19 | 152.231.11.1 | 36 | 238.189.00.1 | 22 |
| 115.788.xx.1 | 13, 19 | 152.400 | 36 | 238.191.11.1 | 23 |
| 115.802.xx.1 | 26 | 152.400.16.1 | 36 | 238.232.11.1 | 22 |
| 115.802.xx.5 | 26 | 152.400 | 36 | 238.233.11.1 | 22 |
| 115.804.xx.1 | 26 | 152.420 | 36 | 238.234.00.1 | 22 |
| 115.804.xx.5 | 26 | 152.421.46.1 | 36 | 238.235.16.1 | 22 |
| 115.805.21.1 | 26 | 152.422 | 36 | 240.026.00.1 | 8, 9, 11, 16, 17 |
| 115.808.xx.1 | 32 | 152.422.46.1 | 36 | 240.027.46.1 | 36 |
| 115.809.xx.1 | 32 | 152.424.00.1 | 36 | 240.031.00.1 | 8 |
| 115.817.xx.1 | 28 | 152.425 | 36 | 240.035.00.1 | 26, 29, 33 |
| 115.817.xx.5 | 28 | 152.426 | 36 | 240.041.00.1 | 18 |
| 115.818.xx.1 | 28 | 152.426.46.1 | 36 | 240.043.xx.1 | 24 |
| 115.818.xx.5 | 28 | 152.434.16.1 | 36 | 240.047.00.1 | 8, 14, 15 |
| 115.819.xx.1 | 32 | 152.435 | 36 | 240.048.xx.1 | 32 |
| 115.820.xx.1 | 32 | 152.439 | 36 | 240.058.00.1 | 11, 16, 18 |
| 115.820.xx.5 | 32 | 152.440.46.1 | 36 | 240.066.00.1 | 5, 16 |
| 115.825.00.1 | 28 | 152.486.16.1 | 36 | 240.067.00.1 | 5, 11, 16 |
| 115.826.00.1 | 28 | 152.489.16.1 | 36 | 240.068.00.1 | 16 |

| Cikkszám | Oldal | Cikkszám | Oldal | Cikkszám | Oldal |
|--------------|----------------------|--------------|----------------------|--------------|--------------------|
| 240.069.00.1 | 8, 7, 11, 14, 15 | 240.639.00.1 | 5, 18 | 241.904.00.1 | 31 |
| 240.072.00.1 | 11 | 240.646.00.1 | 18 | 241.905.00.1 | 31 |
| 240.073.00.1 | 11, 16 | 240.705.00.1 | 8, 10, 12, 14 | 241.906.00.1 | 31 |
| 240.074.00.1 | 5, 11, 16 | 240.712.00.1 | 14, 15 | 241.911.xx.1 | 34 |
| 240.079.00.1 | 13 | 240.750.21.1 | 38 | 241.912.xx.1 | 34 |
| 240.087.00.1 | 11, 18 | 240.771.00.1 | 5, 7, 9, 10, 13 | 241.913.FW.1 | 34 |
| 240.113.00.1 | 10 | 240.803.00.1 | 24 | 241.914.xx.1 | 34 |
| 240.114.00.1 | 8, 10 | 240.813.00.1 | 36 | 241.915.xx.1 | 34 |
| 240.121.xx.1 | 32 | 240.835.00.1 | 10, 17 | 241.916.xx.x | 34 |
| 240.142.00.1 | 24 | 240.840.00.1 | 24 | 241.921.xx.1 | 31 |
| 240.143.00.1 | 25 | 240.841.00.1 | 24, 25 | 241.922.xx.1 | 31 |
| 240.150.00.1 | 24, 32 | 240.850.00.1 | 24 | 241.923.FW.1 | 31 |
| 240.172.00.1 | 13 | 240.870.00.1 | 32 | 241.924.xx.1 | 31 |
| 240.173.00.1 | 5 | 240.871.00.1 | 26, 29, 33 | 241.925.xx.1 | 31 |
| 240.175.00.1 | 11, 18 | 240.872.00.1 | 32 | 241.926.GH.1 | 31 |
| 240.178.00.1 | 11, 18 | 240.874.00.1 | 25 | 241.931.00.1 | 30, 34 |
| 240.180.00.1 | 11, 18 | 240.885.00.1 | 27 | 241.932.00.1 | 27, 29, 31, 33, 35 |
| 240.182.00.1 | 5 | 240.889.00.1 | 27 | 241.933.00.1 | 27, 29, 30, 32, 34 |
| 240.187.00.1 | 9 | 240.890.00.1 | 27 | 241.934.00.1 | 30, 34 |
| 240.190.00.1 | 36 | 240.891.46.1 | 26 | 241.935.00.1 | 34 |
| 240.195.00.1 | 11 | 240.892.00.1 | 26 | 241.936.00.1 | 34 |
| 240.206.00.1 | 13, 18 | 240.893.00.1 | 27 | 241.937.00.1 | 34 |
| 240.233.00.1 | 11 | 240.894.00.1 | 27 | 241.941.00.1 | 30 |
| 240.269.00.1 | 5, 13 | 240.895.46.1 | 27 | 241.942.00.1 | 30 |
| 240.282.00.1 | 8, 7, 11, 12 | 240.921.00.1 | 5, 7, 12, 13, 14, 15 | 241.943.00.1 | 30 |
| 240.284.00.1 | 36 | 240.922.00.1 | 5, 13 | 241.944.00.1 | 30 |
| 240.298.00.1 | 13 | 240.923.00.1 | 12 | 241.945.00.1 | 26, 28, 30 |
| 240.321.00.1 | 5, 7, 10, 11, 14, 15 | 240.925.00.1 | 13 | 241.946.00.1 | 31 |
| 240.322.00.1 | 18 | 240.930.00.1 | 13 | 241.947.00.1 | 31 |
| 240.323.00.1 | 11, 18 | 240.931.00.1 | 13 | 241.993.xx.1 | 38 |
| 240.329.00.1 | 5, 7, 13, 14, 15 | 240.933.00.1 | 20 | 242.012.00.1 | 36 |
| 240.343.00.1 | 24 | 240.934.00.1 | 19 | 242.150.00.1 | 31 |
| 240.457.00.1 | 38 | 240.935.00.1 | 19, 20 | 242.152.00.1 | 31 |
| 240.458.00.1 | 38 | 240.938.00.1 | 5, 18, 19, 20, 21 | 242.154.00.1 | 31 |
| 240.459.00.1 | 38 | 240.966.xx.1 | 28 | 242.155.00.1 | 31 |
| 240.464.06.1 | 38 | 240.973.00.1 | 26 | 242.156.00.1 | 31, 35 |
| 240.465.00.1 | 38 | 241.060.00.1 | 26, 29, 33 | 242.274.00.1 | 16 |
| 240.468.21.1 | 38 | 241.061.00.1 | 25, 33 | 242.484.00.1 | 31 |
| 240.476.00.1 | 5, 11, 12 | 241.162.xx.1 | 28 | 242.523.00.1 | 19 |
| 240.500.00.1 | 11 | 241.164.00.1 | 32 | 242.524.00.1 | 19 |
| 240.501.00.1 | 10 | 241.167.00.1 | 5, 8, 10, 12 | 242.525.00.1 | 19 |
| 240.506.00.1 | 11 | 241.170.00.1 | 9, 11 | 242.555.00.1 | 19 |
| 240.510.00.1 | 11 | 241.295.00.1 | 16, 18, 19 | 242.588.00.1 | 21 |
| 240.512.00.1 | 11, 16 | 241.319.xx.1 | 32 | 242.601.xx.1 | 19 |
| 240.513.00.1 | 16 | 241.323.00.1 | 28 | 242.602.00.1 | 19 |
| 240.514.00.1 | 16 | 241.343.00.1 | 13, 16 | 242.770.00.1 | 26, 28 |
| 240.515.00.2 | 10, 17 | 241.348.00.1 | 13 | 242.771.00.1 | 27, 29, 33 |
| 240.517.00.1 | 26, 29, 33 | 241.349.00.1 | 13 | 242.772.00.1 | 27, 29, 33 |
| 240.519.00.1 | 32 | 241.463.00.1 | 13 | 242.774.00.1 | 26, 28 |
| 240.520.00.1 | 26, 29, 33 | 241.465.00.1 | 16 | 242.775.00.1 | 26, 28 |
| 240.521.00.1 | 16, 28, 32 | 241.475.00.1 | 13 | 242.789.00.1 | 27, 29, 32 |
| 240.522.00.1 | 27, 28, 33 | 241.504.00.1 | 38 | 242.790.00.1 | 33 |
| 240.523.00.1 | 26, 28 | 241.824.00.1 | 13, 19, 20 | 242.805.00.1 | 5 |
| 240.524.00.1 | 26, 28 | 241.826.00.1 | 13 | 242.806.00.1 | 7 |
| 240.525.00.1 | 26 | 241.829.00.1 | 13 | 242.811.xx.1 | 34 |
| 240.531.00.1 | 26, 28 | 241.857.00.1 | 5, 13 | 242.821.xx.1 | 31 |
| 240.533.00.1 | 13 | 241.859.00.1 | 12 | 242.920.00.1 | 21 |
| 240.535.00.1 | 26, 28 | 241.868.00.1 | 5, 7, 12 | 243.005.00.1 | 24, 33 |
| 240.560.xx.1 | 26 | 241.873.00.1 | 19, 20 | 243.007.00.1 | 24, 33 |
| 240.561.xx.1 | 32 | 241.874.00.1 | 5, 19, 20 | 243.008.00.1 | 25, 26, 29, 33 |
| 240.562.xx.1 | 32 | 241.875.00.1 | 5, 19, 20 | 243.009.00.1 | 25 |
| 240.565.00.1 | 26, 28, 32 | 241.878.00.1 | 20 | 243.012.00.1 | 24, 33 |
| 240.622.00.1 | 12 | 241.901.00.1 | 31 | 243.013.00.1 | 24, 33 |
| 240.629.00.1 | 13, 14, 15 | 241.902.00.1 | 31 | 243.047.00.1 | 24, 32 |
| 240.638.00.1 | 12 | 241.903.00.1 | 31 | 243.048.00.1 | 24, 32 |

| Cikkszám | Oldal |
|--------------|-----------------------------|
| 243.088.00.1 | 12 |
| 243.089.00.1 | 13, 21 |
| 243.091.00.1 | 13 |
| 243.092.00.1 | 13 |
| 243.095.00.1 | 12 |
| 243.096.00.1 | 12 |
| 243.108.00.1 | 21 |
| 243.109.00.1 | 21 |
| 243.110.00.1 | 21 |
| 243.118.xx.1 | 21 |
| 243.139.00.1 | 12 |
| 243.179.00.1 | 19 |
| 255.108.00.1 | 38 |
| 256.000.00.1 | 32 |
| 258.236.00.1 | 5, 7 |
| 352.348.00.1 | 38 |
| 352.348.21.1 | 38 |
| 358.826.00.1 | 36 |
| 361.887.16.1 | 36 |
| 362.771.00.1 | 5, 7, 9, 11, 13 |
| 367.789.00.1 | 36 |
| 367.880 | 36 |
| 367.898 | 36 |
| 387.282.00.1 | 36 |
| 405.012.00.1 | 36 |
| 405.116.00.1 | 36 |
| 813.514.00.1 | 5, 7, 9, 16, 18, 19, 20, 21 |
| 816.418 | 5, 7, 8, 10, 12, 22 |
| 816.418.00.1 | 5, 7, 8, 10, 12, 22 |
| 819.298.21.1 | 27 |
| 836.032.00.0 | 22 |
| 836.033.00.0 | 22 |
| 836.123.00.0 | 22 |
| 836.134.00.0 | 22 |
| 836.127.00.0 | 22 |
| 836.134.00.0 | 22 |
| 854.188.11.1 | 36 |
| 854.454.00.1 | 38 |
| 854.467.00.0 | 25, 33 |
| 854.487.00.1 | 36 |
| 858.257.00.1 | 38 |
| 886.241.00.1 | 32 |
| 889.110.11.1 | 18 |
| 891.015.00.1 | 5, 7, 8 |
| 893.601.00.1 | 38 |
| 894.082.00.1 | 5, 7, 9 |
| 894.319.00.1 | 36 |
| 895.589.00.1 | 36 |
| 905.994.00.0 | 7 |
| 990.937.00.1 | 37 |

Geberit Kft.
Office Garden II.
1117 Budapest
Alíz utca 2.

T.: 1 204 4187
F.: 1 204 4190
sales.hu@geberit.com

→ www.geberit.hu