

10° 650 L

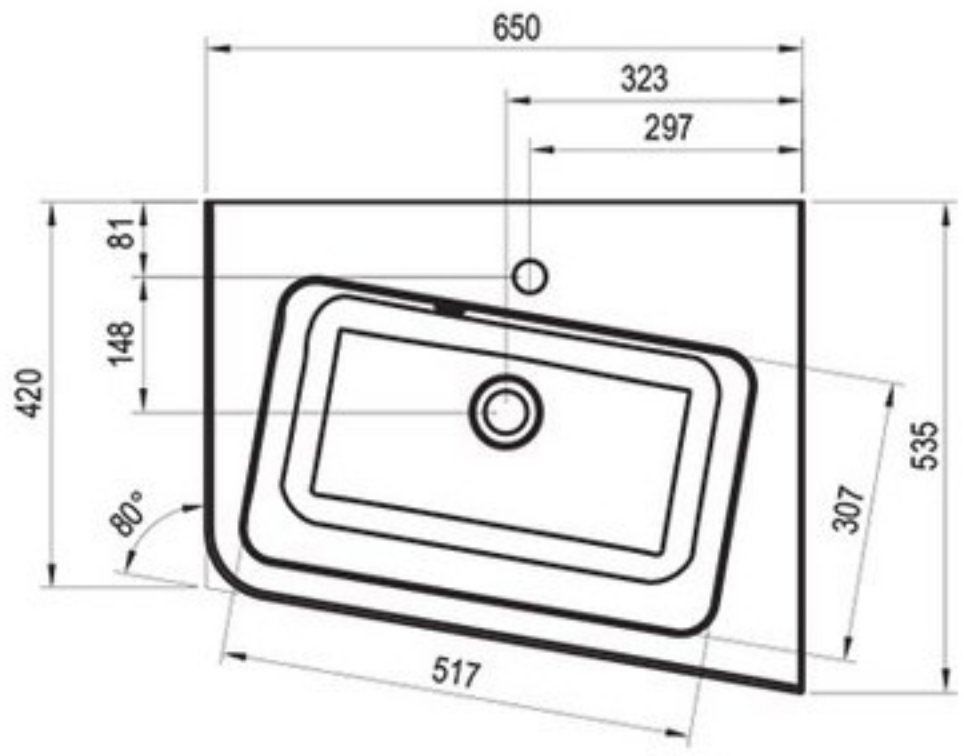

10° 650 R